

Draft 2

TCO Certified

Generation 10, for notebooks



TCO Certified – driving sustainable development in IT products

Established in 1992, TCO Certified is a global sustainability certification for IT products. The organization behind TCO Certified is TCO Development. Certificates are valid worldwide and can be used as proof in all countries, without the need for local adaptation. TCO Certified is available with both general and product-specific criteria for several product categories: displays, notebooks, tablets, smartphones, desktops, all-in-one PCs, projectors, headsets, servers, network equipment and data storage. TCO Certified is also available with only the general criteria for any IT product after consultation with TCO Development.

Comprehensive criteria with a life cycle perspective

Certified products must meet comprehensive environmental and social criteria throughout the life cycle. The criteria are science-based and developed in an open process with TCO Development's international network of stakeholders, which includes users, buyers, industry, NGOs, researchers and subject matter experts. To address the most pressing sustainability challenges and stay current with the latest technology developments, a new generation of TCO Certified is released every three years.

A third-party certification independently verified

TCO Certified is a third-party certification, independent of the IT industry and buyers. It meets the requirements in ISO 14024 Ecolabel Type 1 and has been approved by the [Global Ecolabelling Network](#) as part of the GENICES peer review process. Independent verification organizations, accredited to ISO 17025, verify that products conform with all criteria in TCO Certified. Verification is done both before and after certification, throughout the full validity period of the certificates.

How to apply for certification

At tcocertified.com, you'll find a guide that explains the certification process and lists what you need to do to apply for certification of your products. Compliance with all criteria in TCO Certified is independently verified. It generally takes three to five weeks to receive the certificate, once all documents and the product sample are delivered to the verification organization.

Need help?

Need help getting started? Or, would you like us to explain the certification process in more detail? Our certification team is always here to help. Email us on certification@tcodevelopment.com. Our approved, independent verifiers around the world are also at your disposal, and are able to explain the criteria and certification process in your local language. Contact details are available at tcocertified.com.

About this document

This is TCO Certified, generation 10, draft 1 for notebooks, released in XXX 2024. A notebook is defined as a portable computer, with a display size > 6", that is primarily for battery mode usage. A notebook should have an integrated battery and function without being connected to the wall socket. It may have a touch screen interface. A notebook includes a keyboard, a display, a processor unit and memory storage device. All external cables and external power supplies are considered a part of the notebook. Notebooks with detachable keyboards are still considered notebooks and not tablets if they are delivered together to the end user.

The criteria include:

Mandate: A description of the requirements that needs to be fulfilled, and how conformity is verified. Forms and signatures for application are available in chapter 11 of this document.

Definitions: Explanations of important terms relevant to the criterion.

References: References to sources, presented in chapter 10.

Clarifications: Further details and explanations of the mandate.

Compliance with criteria is independently verified

Compliance with the criteria is verified by verification organizations (verifiers) independent of both the certification body (TCO Development), the applicant and the brand owner. Each criterion includes a description of the proof that must be submitted to the verifier, and to TCO Development together with the application form. This may be a test report or a verification report:

1. A test report presents the results from tests conducted by a test facility accredited to ISO 17025, and is issued by that same facility.
2. A verification report is issued by a verifier approved by TCO Development and includes a summary and a result (pass or fail) based on either:
 - a test report issued by the same test facility,
 - a test report issued by a different test facility, or
 - certificates or other proof from the company or brand owner applying for the certificate.

Editions of TCO Certified

When we publish a new generation of TCO Certified, our ambition is always to maintain criteria levels until the next generation of TCO Certified is launched, which typically happens after three years. Several editions of the criteria document may be released, but will be considered only as updates within the ninth generation, with improved precision of the mandates, test methods and clarifications. To ensure that all currently certified products comply with the new edition of the criteria document, the criteria levels are never raised within a generation.

Table of contents

1 Product and sustainability information	8
1.1 Information to end users	9
1.1.1 Mandate	9
1.1.2 Clarification	10
1.2 Product specification	13
1.2.1 Mandate	13
1.2.2 Clarification	14
1.3 Unique product identifier	15
1.3.1 Mandate	15
1.3.2 Clarification	16
2 Socially responsible manufacturing	18
2.1 Supply chain responsibility	21
2.1.1 Mandate	21
2.1.2 Clarification	23
2.2 Supply chain transparency	31
2.2.1 Mandate	31
2.2.2 Clarifications	32
2.3 Anti-bribery management system	34
2.3.1 Mandate	34
2.3.2 Clarification	35
2.4 Responsible mineral sourcing	36
2.4.1 Mandate	36
2.4.2 Clarifications	37
2.5 Process chemicals management	40
2.5.1 Mandate	40
2.5.2 Clarification	41
3 Environmentally responsible manufacturing	43
3.1 Environmental management system	44
3.1.1 Mandate	44
3.1.2 Clarification	45
3.2 Renewable energy	46
3.2.1 Mandate	46
3.2.2 Clarification	47
3.3 Energy management system	51
3.3.1 Mandate	51
3.3.2 Clarification	51
3.4 Post-consumer recycled content	52
3.4.1 Mandate	52
3.4.2 Clarification	53

3.5 Product carbon footprint	54
3.5.1 Mandate	54
3.5.2 Clarification	54
3.6 Product carbon footprint reductions	56
3.6.1 Mandate	56
3.6.2 Clarification	57
4 User health and safety	58
4.1 Electrical safety	59
4.1.1 Mandate	59
4.1.2 Clarification	59
4.2 Acoustic noise	60
4.2.1 Mandate	61
4.2.2 Clarification	61
5 Product performance	63
5.1 Energy efficiency	64
5.1.1 Mandate	64
5.1.2 Clarification	64
5.2 Display resolution	67
5.2.1 Mandate	67
5.2.2 Clarification	67
5.3 Correlated color temperature	69
5.3.1 Mandate	69
5.3.2 Clarification	70
5.4 Color gamut	71
5.4.1 Mandate	71
5.4.2 Clarification	71
5.5 Color uniformity	73
5.5.1 Mandate	73
5.5.2 Clarification	73
5.6 Color uniformity – angular dependence	76
5.6.1 Mandate	76
5.6.2 Clarification	77
5.7 Color grayscale linearity	79
5.7.1 Mandate	79
5.7.2 Clarification	80
5.8 Luminance level	81
5.8.1 Mandate	81
5.8.2 Clarification	81
5.9 Luminance uniformity	84
5.9.1 Mandate	84
5.9.2 Clarification	84
5.10 Luminance uniformity - angular-dependence	86
5.10.1 Mandate	86

5.10.2 Clarification	86
5.11 Luminance contrast – characters	90
5.11.1 Mandate	90
5.11.2 Clarification	90
5.12 Luminance contrast - angular dependence	93
5.12.1 Mandate	93
5.12.2 Clarification	93
5.13 Keyboard gloss	95
5.13.1 Mandate	95
5.13.2 Clarification	95
6 Product lifetime extension	97
6.1 Product warranty	98
6.1.1 Mandate	98
6.1.2 Clarification	99
6.2 Replaceable components	100
6.2.1 Mandate	101
6.2.2 Clarification	101
6.3 Standardized connectors	104
6.3.1 Mandate	104
6.3.2 Clarification	104
6.4 Product durability	105
6.4.1 Mandate	105
6.4.2 Clarification	106
6.5 Battery longevity	107
6.5.1 Mandate	107
6.6 Battery replaceability	108
6.6.1 Mandate	108
6.6.2 Clarifications	109
6.7 Battery information and protection	110
6.7.1 Mandate	110
6.7.2 Clarification	111
6.8 Secure data removal	112
6.8.1 Mandate	112
6.8.2 Clarification	113
6.9 Standardized external power supply compatibility	114
6.9.1 Mandate	114
6.9.2 Clarification	114
6.10 Repairability index	115
6.10.1 Mandate	115
6.10.2 Clarifications	115
6.11 Security and functionality software updates	121
6.11.1 Mandate	121
6.11.2 Clarification	122

7 Reduction of hazardous substances	123
7.1 Heavy metals	124
7.1.1 Mandate	124
7.2 Halogens	125
7.2.1 Mandate	126
7.2.2 Clarification	126
7.3 Non-halogenated substances	128
7.3.1 Mandate	129
7.3.2 Clarification	129
7.4 Plasticizers	132
7.4.1 Mandate	133
7.4.2 Clarification	133
7.5 Hazardous substances in product packaging	134
7.5.1 Mandate	134
7.5.2 Clarification	134
8 Material Recovery	135
8.1 Product packaging	136
8.1.1 Mandate	136
8.1.2 Clarification	136
8.2 E-waste management	138
8.2.1 Mandate	138
8.2.2 Clarification	138

1 Product and sustainability information

- The IT industry is complex and finding reliable data about products and manufacturing conditions can be a challenge.
- The lack of verified product claims can lead to unfair competition between brands as well as greenwash.
- Accurate and comparable information helps both brands and purchasers make informed decisions and measure their sustainability progress.

Transparency improves decision-making

To drive sustainable development in the complex IT industry, accurate and comparable information about products and manufacturing conditions is needed. Transparency around this type of data also helps purchasing organizations make more informed product choices, and measure and report the true sustainability impact of the certified models they actually buy. Another positive effect of giving purchasers and industry access to verified product claims is that it helps IT brands compare their sustainability performance with peers, and reduces the risk of unfair competition and greenwash.

Providing access to independently verified sustainability data

To increase transparency around certified products, data is collected in TCO Certified. This data makes it possible to measure and report on the sustainability impact of using IT products. To ensure accurate reporting, gathered data is verified by independent experts. In those cases where collected data may be published in a non-anonymous format towards purchasers or other stakeholders, this is explicitly written in the criterion mandate under the headline “The following is submitted to TCO Development and may be published”.

Criteria in chapter 1 focus on:

- Improving product identification of certified product models.
- Helping end users find information on TCO Certified, and what the certification includes.
- Making sure that the product specification of certified products is correct.

1.1 Information to end users

Background

End users must clearly be able to identify which products are certified and what sustainability features the product fulfills.

Applicability

All product categories.

References

The license agreement between TCO Development and the applicant/brand owner.

1.1.1 Mandate

- a. The information document for end users must be written in English or in the local language of the country where the product is to be sold. It must accompany the product in at least one of the following ways:
 1. As a separate digital document found together with the product in the packaging.
 2. Included in a digital user manual.
 3. As a separate digital document that is hosted on the brand owner's website. In this case a direct link to the document must be included in the digital user manual mentioned above.
 4. As a link to the digital document. on the product page that is redirected to when scanning the data carrier as specified in criterion *1.3 Unique product identifier*.
- b. The product and its retail packaging must be labeled with the TCO Certified logo. See clarifications for details.
- c. "TCO Certified" must be mentioned on the brand owner's website(s) where the specific certified product is marketed and or sold.

Submit the following to an approved verifier:

A completed and signed product form (chapter 11.3).

Submit the following together with the application to TCO Development:

A copy of the verification report(s) from a verifier approved by TCO Development.

1.1.2 Clarification

Products that are designed to be installed in a rack (supporting framework to hold hardware modules, typically servers, data storage products and networking equipment) are excluded from “1.1.1 b - labeling of the product and packaging”.

1.1.1 A - information document for end users

No editorial changes to the information document for end users are accepted without consent from TCO Development. The information document for end users is available at tcocertified.com.

If the applicant is separate from the brand owner, the applicant must ensure that the brand owner agrees to fulfill their part of this requirement.

If the information document to end users is included as a link or page in the digital user manual, it must be found in a separate chapter with the headlined “TCO Certified” that is visible in the table of contents.

1.1.1 B - labeling of the product and packaging

The TCO Certified logo must be displayed in one of the following ways:

Alternative A

On a permanent or temporary label. Temporary labels must be affixed to the product with an adhesive or cling-type application. The packaging material that is supposed to be removed in order to get the full functionality of a product (such as a screen protector) is defined as packaging material and not the product in this mandate and thus may not be the place for the product logo.

- a. The logo must be visible on the top or front of the product. (The front of the product is defined as the surface seen when viewing the product from the front and may include the stand. The top is defined as the surface that is seen from the top and the back is the surface that is seen from the back.)
- b. The minimum size of the logo is 16mm in width and 10mm in height.
- c. If the logo is to be placed alongside other logos or graphic elements, a minimum of 2,5mm padding must be used on all sides of the TCO Certified logo.

Exception

If the top and front of the product don't have a contiguous and coplanar area (area used for display or touch input are excluded) which is at least 16mm in width or 10mm in height, then the logo may be placed on the back side of the product.

or

Alternative B

Via electronic labeling displayed on the screen or digital product picture in one of the below ways:

- a. During the startup of the product:
The logo must cover at least 1% of the screen. The logo must be legible and be in color, black, or white; must appear at system start-up, and must be displayed for a minimum of 0,5 seconds.
- b. Via a shortcut on the desktop screen of the product. The shortcut must be in the form of the TCO Certified logo in color and clicking it should link to “the information document for end users” available at tco-certified.com.
- c. If the product does not have a electronic display and do not have a continuous coplanar area (area used for display or touch input are excluded) which is at least 16mm in width or 10mm in height and without other logos or markings: The following must be shown on the page that is redirected to when scanning the data carrier as specified in criterion *1.3 Unique product identifier* without further clicks (scrolling is accepted)
 - Full name of certification, including generation
 - Certificate number of the product, that is a link to the product page in TCO Certified Product finder
 - An image of the TCO Certified logo

TCO Development will consider alternative proposals for electronic labeling on a case-by-case basis.

The retail packaging of the product must be labeled with the TCO Certified logo:

- a. The minimum size of the logo must be 16mm in width and 10mm in height.
- b. If the logo is to be placed alongside other logos or graphic elements, a minimum of 2,5mm padding must be used on all sides of the TCO Certified logo.

The certificate owner and brand owner must also conform with all the other logo rules on color, design, marketing, etc., that are specified in the TCO Certified license agreement appendix 2. The following two paragraphs (§2.2 and §2.5 in appendix 2 of the license agreement) are replaced by the rules listed above if a conflict occurs.

1.1.1 C - Mention of TCO Certified on the brand owner website

- The inclusion of “TCO Certified” only needs to be represented as TEXT - i.e. a link to a specific page is not necessary.
- Instead of mentioning “TCO Certified” directly on the brand owners website(s), the brand owner can fulfill this requirement by including “TCO Certified” as TEXT in a product specific PDF file if it is accessible from the brand owner’s website(s) where the specific certified product is marketed and or sold.

To fulfill this mandate the brand owner must submit a description on where and how the inclusion of “TCO Certified” as TEXT can be found for certified products. The description must include a general example of where the TEXT “TCO Certified” will be represented. The description must be submitted to the verification organization. If the location where TCO Certified will be mentioned as TEXT is changed, a new description must be submitted.

1.2 Product specification

Background

It is important to ensure that each product to be certified is described accurately in the test report and certificate. Therefore, a physical sample of each product to be certified must be sent to an approved verifier, that examines it carefully to ensure that product marking and physical aspects conform with the reported information from the applicant or brand owner. Product weight is an indication of the amount of potential e-waste at end-of-life. By decreasing the product weight, e-waste can be reduced.

Definition

The marking label is a label with the product's electrical rating (voltage, frequency, current), the manufacturer's name, trademark or identification mark, and the manufacturer's model or type reference according to IEC 62368-1 clause 4.1.15.

Applicability

All product categories.

References

1.1.

1.2.1 Mandate

- A marking label must be provided for the product.
- The total weight of the heaviest product configuration including the power supply and cables (without packaging) in kg must be reported.

Submit the following to an approved verifier:

- A copy of the marking label, for the product and all external power supplies.
- A product specification of the heaviest configuration.
- A completed and signed product form (chapter 11.3).

The following is submitted to TCO Development:

- A copy of the verification report(s) from a verifier approved by TCO Development.

The following is submitted to TCO Development and may be published:

- The total weight of the heaviest product configuration including power supply and cables (without packaging) in kg.
-

1.2.2 Clarification

The template must be completed with the requested information about the product. A type key that includes an asterisk (*) for unidentified characters, if any, in the model name and for other identification names must be submitted to the verifier. Only two * may be used in the model type key and each * must include two or more options.

Worst case configuration

There might be several configurations of a product covered by the same certificate. It is necessary that the verification of compliance cover all these configurations. Therefore, the independent verifier must determine the most likely worst-case configuration for compliance with each criterion in TCO Certified. This configuration must be specified in the test reports under each criterion where worst case configuration is used.

The worst-case configuration must be available for purchase. It must be defined through a unique brand owner code, a unique product identifier, or a list of configuration choices that are available at the time of purchase. *If there are several versions of the same component (e.g. due to different suppliers) and the buyer cannot influence which version they get, then the worst-case version of the component must be reported.)*

1.3 Unique product identifier

Background

The criteria ensure that certified products are labeled with a data carrier connected to a unique product identifier. This facilitates circular value chains, enabling efficient and reliable identification of more sustainable products in the marketplace and preparing the product for upcoming EU directives on digital product passports.

Applicability

All product categories.

Definitions

GTIN: Global Trade Item Number

Unique product identifier: A unique string of characters for the identification of products that also enables a web link to the digital product passport.

Digital product passport: a set of data specific to a product accessible via electronic means through a data carrier.

Data carrier: a two-dimensional symbol or other automatic identification data capture medium that can be read by a device.

Serial number: Any alphanumeric string that functions as a persistent and unique identifier for an individual item.

1.3.1 Mandate

Part 1:

The certified product must have a Data carrier containing a Unique product identifier As specified in GS1 digital link standard or equivalent.

Part 2:

When the data carrier is scanned by a device, it must redirect to a website displaying unit-specific product information.

Submit the following to an approved verifier:

- Physical Sample of product equipped with data carrier. Or documentation showing that the product will be marked in the same way as a previously assessed and approved product.
- Sample URL (as encoded in the data carrier)
- Sample URL for the website displaying unit-specific product information.
- GTINs assigned for the product, using the UPI template
- A completed and signed product form (chapter 11.3).

The following is submitted to TCO Development:

- A copy of the verification report(s) from a verifier approved by TCO Development.

The following is submitted to TCO Development and may be published:

- The GTINs assigned with the product, either by range or specific id's.

1.3.2 Clarification

The first time a brand applies for a TCO Certified Generation 10 certificate, A period of 12 months may be granted to implement functionality so that the scanning of the data carrier leads to a unit-specific website.

Unique product identifier specifications

The Unique Product Identity must be encoded into the data carrier according to GS1 digital link URI syntax standard. The minimum required information to include is:

1. Global Trade Identification Number(GTIN) as provided for in standard ISO/IEC 15459-6
2. Product serial number

Example URL: <https://id.brand.com/01/09506001343376/21/4EEE2F4654CA424>

Description of example URL: https://subdomain.domain_name.com/gtin/serialnumber



See Section 5 in [GS1 Digital Link Standard: URI Syntax](#) for more Examples of GS1 Digital Link URIs. It is recommended, but not mandatory, to use the best practices guide from GS1 [GS1 Digital Link: Best practices for creating your QR Code powered by GS1](#)

Data carrier specifications

Accepted types of data carriers:

Qr-code or data matrix

To ensure data carrier quality, the following standards must be followed:

If data carrier is a QR-code: ISO/IEC 18004:2015

If data carrier is a data matrix: ISO/IEC 16022:2006

Placement of data carrier on the product

- A. The data carrier must be placed on the outer casing or on the marking plate.
- B. The data carrier must be placed on a flat surface on the product..
- C. The data carrier must be accessible without using tools.
- D. The brand owner submits documentation or a sample that shows how the product will be marked with the data carrier to an approved verifier.

Products made up of multiple detachable parts:

The data carrier should be attached to at least one of the parts.

Data carrier on product packaging.

It is not required to label the product packaging with an additional copy of the data carrier with the unique product identifier, but it is allowed.

Data carrier Size

Use *Section 5.12.3 GS1 symbol specification in [GS1 General Specifications](#)* as a guide to select an appropriate label size to encode the Digital link URL domain name and product serial number.

Draft 2

2 Socially responsible manufacturing

- Poor working conditions are common throughout the IT product supply chain.
- Child labor, forced labor, excessive overtime and hazardous substances are a risk to workers' health and lives.
- To drive social responsibility, a structured system for continuous improvements is needed, along with strict monitoring to ensure problems are resolved.

Social risk is present throughout the supply chain

Much of IT product manufacturing is carried out in low-wage countries where the labor market lacks clear regulation, and the protection of workers is insufficient. Poor working conditions occur throughout the supply chain. Sustainability risks include child labor, forced labor, and hazardous chemicals used in manufacturing. Excessive overtime leaves a worker with little to no time over for rest, recreation, family or further education. The mineral industry is connected to armed conflicts and human rights abuses, severe health problems for workers, and environmental degradation. As in many industries, the risk of bribery is also present. This must be counteracted as it hinders development, erodes justice, undermines human rights and interferes with the fair and efficient operation of markets.

Our approach: driving worker safety, human rights and closing non-conformities

Driving social responsibility throughout the complex IT product supply chain requires a clear and systematic approach. TCO Certified includes a framework that encourages proactive work and helps brand owners structure their work with sustainability. Corrective action plans must be developed and implemented within a set timeframe. To drive change where it's needed the most, monitoring of high-risk factories is intensified.

Criteria in chapter 2 focus on:

- Ensuring safer working conditions by requiring that the code of conduct is implemented throughout the supply chain.
- Guiding the industry to more sustainable practices with a structured system for continuous improvement.
- Requiring transparency about which suppliers are being used to increase accountability.
- Taking the next step in combating corruption in the supply chain by requiring compliance with the more ambitious anti-bribery standard ISO 37001.
- Continuing independent verification of due diligence all the way to the source of the minerals, to ensure that minerals are sourced responsibly.
- Requiring that all cleaning process chemicals are assessed by an independent toxicologist and benchmarked as a safer alternative before being used in the manufacture of certified products. The same principle applies also to flame retardants and plasticizers, covered in chapter 7.

Definitions

3TG: tin, tungsten, tantalum, gold.

Anti-bribery management system: A system designed to help organizations instill an anti-bribery culture and implement appropriate controls to detect and address bribery.

Brand owner: The company or organization owning or controlling the brand name of the product.

Bribery: Giving or receiving an unearned reward to influence someone's behavior.

Business licence: A business licence covers an independent work unit, which means it has its own separate production areas, operation and management system, including but not limited to recruitment, working hours system, wage and benefit system, factory rules, etc. and all employees that under contract are dedicated to that factory.

Cleaning solvents: Chemicals and chemical mixtures used to remove contaminants, unwanted materials, and/or manufacture process residues (e.g. lubricants, adhesives, solder flux residues, plastic residue, and mold releases). Examples of process chemicals used for cleaning include: solvents, aqueous detergent solutions, stencil/ink removers, adhesive removers, solvent vapor degreaser solutions, ultrasonic parts cleaner solutions, photo-resist strippers, and solder-defluxing solutions.

Conflict-affected and high-risk areas: Areas in a state of armed conflict, fragile post-conflict areas, and areas witnessing weak or non-existing governance and security, such as failed states. In these areas, there are often widespread and systematic violations of international law, including human rights abuses.

Corrective action plan (CAP): A list of actions the brand owner is responsible for implementing within a set timeframe to address a specific problem.

Corruption: Gaining an advantage through illegitimate means. Bribery, abuse of power, extortion, fraud, deception, collusion, cartels, embezzlement and money laundering are all forms of corruption.

CPA: Clean Production Action. Developers of GreenScreen® for Safer Chemicals.

Final assembly factory: A final assembly factory is where the final assembly of the certified product takes place and is defined as the whole operation covered by a business license. If the final assembly of the product is divided over more than one factory, all are considered final assembly factories.

Licensed GreenScreen Profilers: Toxicology firms licensed by CPA to provide GreenScreen assessment services for a fee to clients.

Next-tier suppliers: Suppliers to the final assembly factory of parts and packing materials for the certified product.

Process chemical inventory: A record the factory keeps showing the process chemicals used to manufacture certified products.

Process chemicals: Chemicals (individual chemicals or mixtures) used during the manufacture of a product and/or to maintain related production equipment. Process chemicals are not intentionally fully incorporated into the product. Cleaning agents, lubricants and additives are examples of process chemicals.

Refining: A process that increases the grade or purity of a metal.

Responsible Minerals Assurance Process (RMAP): Independent third-party assessment of smelter and refiner management systems and sourcing practices to validate conformance with RMAP standards.

Responsible minerals initiative (RMI): Member initiative for implementing minerals supply chain due diligence.

Smelting: The process of applying heat to ore in order to extract a base metal.

SMT: Surface-mount technology is a method in which the electrical components are mounted directly onto the surface of a printed circuit board (PCB). An electrical component mounted in this manner is called a surface-mount device (SMD).

Draft 2

2.1 Supply chain responsibility

Background

Social responsibility is a continuing challenge throughout the IT supply chain. From raw materials extraction to final assembly, working hours, health and safety and forced labor are examples of industry-wide issues. However, for those who want to drive greater social responsibility, a major issue is the complexity of the IT product supply chain. It includes many suppliers that are spread all over the world.

The most basic aspect of social responsibility in the supply chains is to define who holds the responsibility. After this is done, the level of conformity and the implementation in the supply chains need to be defined. Finally, to make sure that problems are solved and improvements are made, independent verification and follow-up is crucial. Continued monitoring is essential, even after closure. TCO Certified offers a structured platform to guide industry progress:

- The responsibility for correcting non-conformities is placed on the brand owner, which is at the top of the product value chain.
- Define minimum standards of the brand owner code of conduct covering the manufacturing of the certified product.
- We provide a control system to ensure that the brand owner takes responsibility in the supply chains of the certified product and works in a structured way in accordance with the code of conduct.
- By including a system of consequences for continued non-conformities, we incentivise the brand owner to work proactively.

Applicability

All product categories.

References

2.1, 2.2, 2.3

2.1.1 Mandate

By signing this mandate, the brand owner agrees to (1.) the Commitment and agrees to conduct (2) the Structured work. Additionally, TCO Development requires that the brand owner shows (3) Proof of the commitment and the structured work by allowing inspections in the supply chains of the certified product, sharing audit reports and CAPs, and providing other documented proof described below.

1. Commitment

- The brand owner must have a public code of conduct for the manufacture of certified products considered consistent with the following principles and rights at work:
 - ILO's fundamental conventions: 29, 87*, 98*, 100, 105, 111, 138, 155, 182 and 187.
 - The UN Convention on the Rights of the Child, Article 32.

- All applicable local and national health and safety and labor laws effective in the country of manufacture, and a maximum 60-hour workweek including overtime*.

*See clarifications 1 and 2

2. Structured work

- The brand owner must register each final assembly factory and each factory manufacturing display panels >10" for the product model(s) that the application covers to TCO Certified Portal and supervise the implementation of the code of conduct at these factories.
- The brand owner must ensure all registered factories have identified and communicated the code of conduct to their next tier suppliers of parts for certified products.

3. Proof

- The brand owner code of conduct and communication process must be annually verified during the annual review process.
- Accepted initial audit reports, closure audit reports and corrective action plans for each registered factory must be uploaded to TCO Certified Portal.
- The supply chain identification template (SCIT) must be submitted. The template must be uploaded to TCO Certified Portal for only the registered final assembly factory. An updated SCIT may be required to be resubmitted at any time. Data on the following suppliers for the following parts must be included in the SCIT:
 - Product housing: Enclosure (chassis) including stand: Parts >0.5 grams.
 - Printed circuit board: Mainboard (motherboard) and power board.
 - External cables: Power and peripheral connecting cables.
 - Processors and memory: CPU, GPU, chipset, DRAM, RAM, SSD and HDD.
 - Battery: Remote power source of the product.
 - Power supplies: internal and external.
 - Display panel (all sizes).
- TCO Development may also require seeing audit reports and corrective action plans from factories further up the supply chains of the certified product to ensure that corrective actions have been successfully implemented.
- TCO Development additionally requires that supporting documentation be verified by an independent verifier approved by TCO Development.
- TCO Development may commission random factory audits (spot checks) at any factories registered to TCO Certified Portal.

Submit the following to an approved verifier:

Once a year at the Senior Management Representative annual review:

- The brand owner's public code of conduct communicated to the supply chains of the certified product. The code of conduct must be considered consistent with this mandate.
- Supporting Information on the routines of how management and workers in each registered factory are informed about the code of conduct.
- A completed and signed brand owner form covering the certified product. (Chapter 11.1.)

For each application:

- A copy of the factory list in the CB certificate with the names and addresses of all final assembly factories manufacturing the certified product model. If any of these factories are not registered to TCO Certified Accepted Factory List, the brand owner must submit the factory identification template to register the factory or prove that the factory is not manufacturing the certified product model.
- A photo of the display panel marking label.
- Check that the brand name is listed as compliant without missed due dates on TCO Certified Portal. Any missed due dates will mean a certification application cannot proceed until the required documentation is submitted and the due date is extended or marked compliant.

For each final assembly factory and factory manufacturing display panels >10" for the certified product:

- The most recent independent initial audit report, corrective action plan for each non-conformity and closure audit report must be uploaded to TCO Certified Portal. The audit interval is determined by the risk category of the factory. The risk category is set by the verifier according to the process described under: **Audit report and factory risk categorization.**
- The supply chain identification template (SCIT) must be completed and submitted to TCO Certified Portal for each registered final assembly factory.

The following is submitted to TCO Development:

- A copy of a verification report from a verifier approved by TCO Development.
- A copy of an English version of the public code of conduct must be uploaded to TCO Certified Portal.
- An independent audit and a corrective action plan for each non-conformity must be reported to TCO Certified Portal at an interval determined by the risk category of the registered factory for the certified product.

The following is submitted to TCO Development and may be published:

- The status (YES/NO), if all factories manufacturing the certified products are category 3, is automatically collected.

2.1.2 Clarification

General clarifications

The mandate is a social performance mandate, and criteria are based on ILO's (International Labour Organization) fundamental conventions and local legislation. The mandate requires that the brand owner comply with the minimum standards for code of conduct, inspection and corrective action engagement regarding the supply chain of the certified product.

* Convention 87 and 98: Collective bargaining and freedom of association: All workers must have the right to form, join and organize trade unions of their choice and to have them bargain collectively on their behalf with employers. In situations where this is restricted under law, employers must allow workers to freely and democratically elect their own representative(s) for the purpose of defending the rights and interests of workers.

* Local labor law: The limit and enforcement of local law regarding working hours differ tremendously globally. To harmonize with other initiatives and to find a reasonable level for the industry, the criteria in TCO Certified sets a maximum 60 hour workweek, including overtime, as a global requirement regardless of the local law.

* 60 hour working week: This criterion sets a global limit for weekly working hours that includes overtime based on ILO convention 1 (56 hours per work week including overtime). An additional four hours per workweek is given to harmonize with SAI and RBA. Therefore, workweeks, including overtime, are not to exceed 60 hours, and workers must receive at least 1 day off every 7 consecutive days.

TCO Certified has established thresholds for non-compliance with working hours. For factories up to 15000 employees, the following is applicable;

- Minor non-compliance: up to 2% of the total workforce working between 60 and 72 hours per week
- Major non-compliance: 2% - 15% of the total workforce working between 60 and 72 hours per week
- Priority non-compliance: More than 15% of the total workforce working between 60 and 72 hours per week or any percentage of the workforce working above 72 hours per week.

The verification process

Proof documentation must be submitted to an independent verifier approved by TCO Development. It is the verifier's responsibility to request any additional documents necessary for the review. The verifier will evaluate the information received from the brand owner according to the principles described below (1-5).

1. The code of conduct:

The brand owner must have their code of conduct covering the supply chains of the certified product reviewed annually by an approved verifier. If the code of conduct has not changed since the previous annual review, the brand owner does not have to submit it again. The Senior Management Representative (SMR) for supply chain responsibility must report this to an approved verifier. The approved verifier carries out the verification during the annual review process.

- The code of conduct must be consistent with all parts under **1. Commitment.**
- The contents of the code of conduct must have been adopted by the brand owner's board and addressed by management.
- The code of conduct must cover the manufacturing of the certified product.

2. Information about the code of conduct:

The brand owner must annually submit a description of how management and workers at all registered factories manufacturing certified products are informed about all parts of the code of conduct. Proof of training classes or other means of worker training and how the factory measures the effectiveness of the worker training must be submitted for review. The training must be held specifically for the purpose of training and not just part of a regular business review meeting. If there are no changes to the communication routine since the previous

annual review, then the brand owner does not have to submit it again. In this instance, the SMR must report this to an approved verifier. The approved verifier carries out the verification during the annual review process.

Accepted proof of compliance. All parts must be fulfilled:

- Annual training on all parts of the code of conduct for management and workers or worker representatives at registered factories of the certified product.
- Training is through workshops, e-learning, or online training programs.
- There is a questionnaire (self-assessment) process to assess management and worker understanding and conformity with the code of conduct.

3. The brand owner form

A completed and signed brand owner form covering the certified product (Chapter 11.1.) to confirm that one or all products that are included in the application to TCO Development comply with this criterion.

4. Factory registration on TCO Certified Portal

For each certified product, each final assembly factory and each factory manufacturing display panels >10" for the certified product must be identified and registered to TCO Certified Portal.

The approved verifier will ensure that factories are listed on TCO Certified Accepted Factory List.

- Factories are registered to TCO Certified Portal Accepted Factory List using the factory identification template.
- The SCIT must be submitted for each final assembly factory for the certified product. It is not necessary to submit a SCIT for the display panel factories.
- Each time a factory is removed, added or updated in any way, the brand owner must ensure that this information is updated on TCO Certified Portal by submitting the factory identification template to an approved verifier. The template is downloaded from tcocertified.com.

5. Independent social audit reports

The brand owner must ensure that TCO Certified Portal is continuously updated with the most recent independent initial audit report and corrective action plans for all non-conformities found during the audit from all registered factories manufacturing the certified product.

Brand owners or applicants/manufacturers must submit audit reports and corrective action plans to an approved verifier for upload to TCO Certified Portal.

Factory audit intervals are determined by the risk category of the factory.

1. Independent audits must be conducted by organizations accredited to ISO 17021 and carried out by SA8000 or RBA lead auditors who are APSCA certified. The lead auditor's APSCA membership number must appear in the audit report.
2. Accepted audits:
 - a. SA8000,

- b. RBA VAP,
- c. Other audit types, if independently verified to be of equal quality to one of the accepted audits (a or b). This includes auditor qualification, audit process (e.g. triangulation of non-conformities), reporting and CAP. Verification will be conducted by an approved verifier before an alternative audit is accepted as proof.

Defining the factory risk category and audit intervals

A factory new to TCO Certified Portal must be independently audited using an accepted audit type. Any SA8000 certificate or RBA recognition diploma must be submitted with the initial audit report. A factory is assigned a category 1, 2 or 3 based on the risk categorization procedure below.

Brand owners new to TCO Certified or applying for certification to a new product category must undergo a risk assessment. This is for TCO Development to assess the likelihood of fulfilling the requirements within the given time. If the brand owner or factory is considered a higher risk for receiving an extended time (for example: a history of non-compliance), an audit report and a corrective action plan must be submitted before the factory can be registered to TCO Certified Portal.

Lower risk countries

Some countries are considered as lower risk of social non-conformities by the SA8000 Country Risk Assessments Process, which is based on World Governance Indicators (WGI). These countries include but are not limited to: EU countries, USA and Japan. Country risk level is a factor that is considered when setting category levels 2 and 3.

TCO Certified Accepted Factory List

All brand owners, applicants and verifiers who have access to TCO Certified Portal will have access to see TCO Certified Accepted Factory List of registered factories. This list includes information such as the risk category, audit non-conformities and due dates for submitting supporting documentation. Access to information for factories directly owned by a brand owner is limited to that brand owner.

Risk categorization procedure.

Initial audits are required at regular intervals. The audit interval is based on the factory risk category.

- An **initial audit** covers the whole factory and this criterion.
- A **closure audit** covers at least the open non-conformities from the latest initial audit.
- An initial audit is more comprehensive and is accepted as a closure audit.
- Audits older than 12 months are not accepted.

Initial risk categorization

- Risk category 1 is given to all new factories entering TCO Certified Portal, TCO Certified Accepted Factory List. Factories cannot continue as category 1 for more than 18 months or return to category 1 once they have been category 2 or 3.

Risk category 1 (higher risk choice).

Initial audit

- Only risk category 1 factories receive up to 18 months to achieve risk category 2 or 3. Only initial audits less than 12 months old from the date the factory is registered on TCO Certified Portal are accepted. Any priority and major non-conformities to TCO Certified must be independently verified closed with a closure audit within the time period specified in the table below. The due date for achieving category 2 or 3 appears on TCO Certified Portal for each active factory.

Audit status on initial factory registration date	Priority and/or Major non-compliances	Months to achieve category 2 or 3
Without an initial or closure audit.	Unknown	18 months to conduct an initial and closure audit
With an initial audit report less than 6 months old	Yes	12 months to conduct a closure audit
With an initial audit report less than 12 months old	Yes	6 months to conduct a closure audit

Corrective action plan

- For each non-conformity to the mandate commitment, a corrective action plan must be uploaded to TCO Certified Portal. It must include closure deadlines set by the audit program to complete each corrective action.

Closure audit

- If there are major or priority non-conformities in the initial audit, a closure audit must be submitted within the remaining time (see table above). The due date for the closure audit appears on TCO Certified Portal. The corrective action plan must be completed for minor non-conformities, but it is not necessary to submit the closure audit.

Re-categorization

- When all non-conformities other than minor are closed, the factory will be categorized as risk category 2. If the factory is also placed in a lower-risk country or certified according to SA8000, it will be categorized as 3 instead of 2.

Final assistance

- If the factory has been categorized as a risk category 1 for 18 months, then the factory management may receive final assistance toward conformity through TCO Certified Active Monitoring Program. If the brand owner or factory decides not to commit to the program, the factory will be removed from TCO Certified Accepted Factory List, and the factory will no longer be allowed to manufacture products certified to TCO Certified.

Risk category 2 (moderate risk choice).

Initial audit

- For risk category 2, the factory must be audited every 24 months. A new initial audit report must be uploaded to TCO Certified Portal during the 24-month audit period, and all major and priority findings must be independently verified closed within this time. The due date for submitting audit proof to retain a place on TCO Certified Accepted Factory List is shown on TCO Certified Portal.

Corrective action plan

- For each non-conformity to the mandate in TCO Certified, a corrective action plan must be uploaded to TCO Certified Portal. It must include closure deadlines set by the audit program to complete each corrective action.

Closure audit

- If there are major or priority non-conformities, a closure audit must also be uploaded to TCO Certified Portal during the 24-month audit period. If the factory only has minor non-conformities, the corrective action plan must be completed, but it is not necessary to upload the closure audit to TCO Certified Portal. The closure of minor non-conformities will be verified in the next initial audit.

The initial audit should be conducted at least 6 months before the factory audit due date on TCO Certified Portal to give time for a closure audit (if one is necessary).

Failure to retain category 2

- Failure of the factory to retain category 2 within the due date will cause it to be flagged on TCO Certified Portal, which means no certification applications for products manufactured at the factory are approved until the remaining non-compliances are closed. Additional time to close remaining non-compliances may be applied following a risk assessment of the reasons behind the failure to close the non-compliances on time and the closure time plan submitted by the factory. If the brand owner or factory decides not to commit to retaining category 2, the factory will be removed from TCO Certified Accepted Factory List, and the factory will no longer be allowed to manufacture products certified to TCO Certified.

Risk category 3 (lower risk choice).

Initial audit

- For risk category 3, the factory must be audited every 36 months. A new initial audit must be uploaded to the TCO Certified Portal during the 36-month audit period, and all major and priority findings must be independently verified closed within this time. The due date for submitting audit proof to retain a place on TCO Certified Accepted Factory List is shown on TCO Certified Portal.

Corrective action plan

- For each non-conformity to the mandate in TCO Certified, a corrective action plan must be uploaded to TCO Certified Portal. It must include closure deadlines set by the audit program to complete each corrective action.
 - If the factory is SA8000 certified, then the non-conformities are solved following the SA8000 certification procedure.

Closure audit

- If there are major or priority non-conformities, a closure audit must also be uploaded to TCO Certified Portal during the 36-month audit period. If the factory only has minor non-conformities, the corrective action plan must be completed, but uploading the closure audit to TCO Certified Portal is not required. The closure of minor non-conformities will be verified in the next initial audit.
 - A valid SA8000 certificate is considered proof that major and priority non-conformities are monitored regularly by SAAS-accredited verifiers and that issues are being solved.

The initial audit should be conducted at least 6 months before the factory audit due date on TCO Certified Portal to give time for a closure audit (if one is necessary).

Additional clarifications that are valid for all risk categories

- If the audit program and lead auditor accepts an offsite closure audit it will also be accepted in TCO Certified.
- If proven conditions change, such as when non-conformities are found during a spot check, the risk categorization will be re-assessed.
- A major non-compliance given to a control point in the audit report for the only reason that working hours do not meet the stricter local legislated levels than the 60 hour workweek permitted in TCO Certified may have this rating altered to compliance on TCO Certified Portal on condition that the 60 hour working week requirement is met.
- Closure of priority findings within the CAP deadline will be monitored by TCO Development through the spot check program.

On-site factory inspection initiated by TCO Development (spot checks).

TCO Development reserves the right to require full audit reports and conduct or commission on-site inspections at factories registered on TCO Certified Portal as manufacturing the certified product to monitor continued compliance to obligations in this criterion. The planning of social audits will be done in cooperation with the Senior Management Representatives appointed by the brand owner, accepted social auditors and factory management. Factory audits are announced up to two weeks in advance.

Social audits initiated by TCO Development will be realized on a judgment sample basis, in each case decided upon by TCO Development. Audit results will be shared with the audited factory management and all the brand owners listed using the audited factory to combine the effort to close any non-compliance.

Spot check audits are financed by TCO Development. If priority non-conformities are found and further investigations are necessary, the license holder must cover this cost.

The verifier approved for supply chain responsibility

Only an independent verifier approved by TCO Development has the authority to approve the following:

For each brand owner:

- Code of conduct.
- Communication of the code of conduct.
- Supporting documentation.
- Conduct reviews with a senior management representative.

Other assessments

- Review evidence that could prove that another audit protocol can be considered “equal quality to other approved audit protocols”. This includes but is not limited to auditor qualification, audit process, reporting and corrective action plan.

The list of approved verifiers is found at tcocertified.com.

Draft 2

2.2 Supply chain transparency

Background

Supply chain transparency includes two vital parts: a) the extent to which information about a company and its sourcing locations is made public to end-users and stakeholders and b) the company's process of taking action through supply chain visibility to manage it effectively. Companies struggle to achieve supply chain transparency since they lack a solid process and structure to manage risks and monitor behavior in their extended supplier network. Without visibility into their supply chains, brand owners create a blind spot where damage to reputation can emerge.

Transparency toward an independent party provides a company not only with the possibility to measure its own performance in key areas against its peers but also a way to share and gain knowledge about solutions. Supply chain transparency requires a solid management system, where improvements are achieved by acting on responses to shared information.

Applicability

All product categories.

2.2.1 Mandate

The brand owner must appoint a Senior Management Representative (SMR) for supply chain responsibility for the certified product, who reports directly to senior management.

Irrespective of other duties, this person must have the authority to ensure that the certified product meets the supply chain criteria in TCO Certified.

The SMR has access to TCO Certified Portal and must ensure that the due dates for submitting supporting documentation are complied with.

The SMR is responsible for the brand owner annual review process being completed with an approved verifier, and the report is uploaded to TCO Certified Portal before the annual due date.

Submit the following to an approved verifier:

Once a year at the Senior Management Representative interview:

- A completed annual review report.
- A completed and signed brand owner form covering all certified products and brand names used (chapter 11.1)

The following is submitted to TCO Development:

- The report from the annual review must be uploaded to TCO Certified Portal.
- A copy of a verification report from a verifier approved by TCO Development.

The following is submitted to TCO Development and may be published:

- The status (Yes/No & link to public list), if all final assembly factories manufacturing the certified product are listed publicly by the brand owner.
-

2.2.2 Clarifications

General clarifications

The aim of the mandate is to create transparency between TCO Development and senior management at the brand owner company of the certified product.

Senior Management Representative (SMR) details

The required details of the SMR must appear in TCO Certified Portal, and the SMR must be available for dialogue in English with TCO Development and verifiers throughout the validity of all the brand owner's certificates.

If the appointed SMR is changed, then details of the new SMR must be updated in TCO Certified Portal. TCO Development must be informed immediately.

The SMR must ensure that TCO Certified Portal is up to date, covering the following:

- Name, title, telephone number and email address of the SMR.
- A valid annual review report.

SMR and annual review

The annual review must be done with one of the verifiers approved by TCO Development. It is booked and paid for by the SMR company. The purpose is to ensure that the appointed person has the necessary authority and that the company works in a structured way to implement the points covered in the annual review questionnaire.

If the brand owner has more than one brand name registered, the review must cover each brand name respectively and ensure that all requirements in TCO Certified are fulfilled. The verifier must ensure that it is intuitive for anyone searching for the required information on each brand name's website where to find the information. In some cases, this means that it must be publicly stated who owns the brand name or that links are provided to the documents on the brand owner's website.

As part of the annual review process, all questions must be answered and submitted to the verifier before the interview. During the part of the review questionnaire that covers the section on social performance, the SMR will be required to explain the brand owner's work toward a socially responsible supply chain of the certified product and provide supporting documentation where needed. It is recommended that SMRs involve colleagues in the meeting who can provide the necessary expertise in the areas covered by the questions. The interview part of the review process will likely be an online meeting. If it is not possible to have an online meeting or the interview does not obtain an acceptable quality due to language difficulties, then the verifier may require a face-to-face interview. TCO Development has the right to participate in the interview with the SMR. In this case, TCO Development will cover its own expenses.

The final report from the annual review is then uploaded to TCO Certified Portal by the verifier. The annual review questionnaire is revised every third year, following the launch of a new generation of TCO Certified.

An evaluation is made based on the review results regarding the voluntary public disclosure of final assembly factories. There is no mandatory level, but this information may be shared with purchasers.

The link to the brand's publicly disclosed factories (if available) is taken from the review results and entered into TCO Certified Portal. After the report is uploaded, the verifier cross-checks the publicly disclosed factories at the provided link against the final assembly factories used by the brand to manufacture certified products in TCO Certified Portal.

To count a final assembly factory as publicly listed, it must be made public on the brand owner website and state that the brand owner has a business relationship with those factories. The factory information must show at least the supplier name, factory full address and type of products manufactured at the factory.

About the annual review questionnaire benchmarking

The annual review questionnaire is an independent assessment of the brand owner's risk management of the supply chain of the certified product and is part of TCO Development's capacity-building work with brand owners.

The SMR is responsible for answering all questions and providing supporting documentation where needed. Answers are verified and the level of achievement is benchmarked by the verifier..

For the annual SMR interview questionnaire is intended to gather information on the actual level of social commitment, identify capacity-building possibilities, share solutions, and assist in developing future generations of TCO-certified criteria. Feedback to the brand owner is given in the form of a report and table showing the brand owner's final grading (after the interview) compared to other certifying brand owners (all brand names are kept anonymous). This helps the brand owner identify areas for improvement and measure their progress within the industry.

Result data will also be used to risk assess factories of the certified product for the spot-check program. In this program, TCO Development orders annual factory audits according to the code of conduct by independent auditors at a number of final assembly factories where certified products are manufactured.

The annual review questionnaire and guidelines for the annual review process are public and available for download at tcocertified.com

2.3 Anti-bribery management system

Background

Bribery is a widespread phenomenon. It raises serious moral, economic and political concerns, undermines good governance, hinders development and distorts competition. It erodes justice, undermines human rights, and hinders poverty relief. It also increases the cost of doing business, introduces uncertainties in commercial transactions, increases the cost of goods and services, diminishes the quality of products and services, which may lead to loss of life and property, destroys trust in institutions and interferes with the fair and efficient operation of markets.

Organizations are responsible for preventing all forms of corruption within their businesses and supply chains. To do so, organizations must align their business policy, monitoring and enforcement mechanisms with internationally recognized best practices against all forms of bribery.

With TCO Certified, brand owners that apply for product certification are reviewed by an independent reviewer, who assesses the brand owner's anti-bribery management system to ensure that it meets the requirements of ISO 37001.

Applicability

All product categories.

References

2.4.

2.3.1 Mandate

The brand owner must have internal processes and routines in place to prevent and respond to all forms of bribery, covering all business activities connected to the certified product. This includes ensuring that the supply chain of at least the certified product aligns with the anti-bribery management system standard ISO 37001.

Submit the following to an approved verifier:

- A completed and signed brand owner form covering the certified product (chapter 11.1).
- An ISO 37001 certificate or the anti-bribery review report by an approved verifier.

The following is submitted to TCO Development:

- A copy of a verification report from a verifier approved by TCO Development.
-

2.3.2 Clarification

The brand owner's anti-bribery management system covering all business activities connected to the certified product, including the supply chain, must be considered to be aligned with ISO 37001. If an ISO 37001 certificate is unavailable as proof, the brand owner can complete the questionnaire and take part in a follow-up verification review with an approved verifier.

A follow-up review of the brand owner anti-bribery management system will be in the form of a questionnaire and included in the first annual review with the assigned Senior Management Representative (SMR) for supply chain responsibility.

Each answer to the questionnaire will be graded using: Green is aligned, yellow is partial alignment and red is no alignment. A completed questionnaire and supporting documentation must be submitted to the verifier before the review. These will be verified in the online review between the verifier and the brand owner SMR and any experts responsible for anti-bribery the SMR wishes to include.

Verification guidelines

- Alignment to ISO 37001 without providing a valid certificate is when all answers are scored green (except 12.1) in the anti-bribery section of the annual review questionnaire. When all required points are aligned, there is no need to include anti-bribery in the following annual reviews unless requested by TCO Development.
- If any point (except 12.1) is scored yellow or red, a corrective action plan must be made, and the point will be included in the following annual review and must be scored green.
- Only question 12.1 (covering independent verification of the anti-bribery management system) can be graded yellow or red since this review in TCO Certified is considered an independent verification of the anti-bribery management system.

2.4 Responsible mineral sourcing

Background

Minerals such as tin, tantalum, tungsten, gold and cobalt are connected to armed conflicts and human rights abuses in the world's regions where they are extracted. Unsafe mining methods also lead to severe health problems for workers and environmental degradation in local communities. Since the mineral supply chain can include hundreds of suppliers, from mines and smelters or refiners to final production, making informed choices about mineral sourcing, from extraction to finished product, is challenging.

TCO Certified drives more responsible mineral sourcing in all countries where the mining industry and trade are present. Suppliers must adopt a responsible approach to mineral sourcing, irrespective of where they operate. TCO Certified goes beyond the current definition of conflict minerals and requires brand owners to include cobalt in their due diligence process. To drive widespread, positive impacts faster, due diligence and risk reporting are standardized, focusing on long-term, continuous improvement.

Applicability

All product categories.

References

2.5, 2.6, 2.7, 2.8.

2.4.1 Mandate

The brand owner must:

- Have a supply chain policy for responsible mineral sourcing for the certified product that can be considered to cover at least 3TG and cobalt. The policy must be both public and communicated to the supply chain.
- Conduct a reasonable country of origin inquiry for smelters or refiners (SORs) of at least 3TG and cobalt for the certified product that follows the OECD Due Diligence Guidance for Responsible Supply Chains of Minerals from Conflict-Affected and High-Risk Areas process.
- Annually demonstrate that at least 70% of the total number of SORs for 3TG and cobalt in the supply chain of the certified product are conformant (certified) to an accepted independent third party due diligence program.
- Annually submit the completed responsible mineral sourcing template with all the information required in the template.

Submit the following to an approved verifier:

- The most recent version of the public responsibly sourced minerals policy and a description of how it is communicated to the supply chain of the certified product.
- A description of the brand owner's structured work on identifying risk areas in the supply chain of the certified product with supporting documentation.
- The responsible mineral sourcing template (a TCO Certified template) and supporting documents must be completed and submitted to TCO Certified Portal before the brand owner annual due date stated in TCO Certified Portal and cover the supply

chains of the final assembly factories of the certified product registered by the brand owner on TCO Certified Accepted Factory List.

- A completed and signed brand owner form covering the certified product (chapter 11.1).

The following is submitted to TCO Development:

- A copy of a verification report from a verifier approved by TCO Development.
- A copy of the responsibly sourced minerals policy in English. (Must be uploaded to TCO Certified Portal.)

2.4.2 Clarifications

Responsibly sourced minerals policy

The responsibly sourced minerals policy is an essential statement by the brand owner. It must reflect the brand owner's commitment toward responsible sourcing of minerals and the expectations that their raw material suppliers adhere to the policy.

Verification guidelines:

The verifier must verify that the responsibly sourced minerals policy can be considered to cover at least 3TG and cobalt for all the certified products, that it is public, and that it is clear how the policy is communicated to suppliers.

- "Public" means that the policy is visible on the brand owner's website or is included in the brand owner's annual sustainability or responsible minerals report, and that it is communicated that it covers all the brand names the brand owner has registered on the TCO Certified Portal.
- "Communicated" could be part of a contract and/or a written agreement with suppliers.

To verify the level of strictness, the policy must require at least the following:

- That suppliers uphold the policy.
- That suppliers neither directly nor indirectly finance armed groups in conflict-affected regions.
- That suppliers neither tolerate nor contribute to human rights abuses that include forced labor, child labor and environmental degradation.
- A commitment to supporting responsible sourcing from regions where specific mining operations may present risk.
- Suppliers work with the brand owner to identify SORs of 3TG and cobalt in the supply chain and report details using a conflict minerals reporting template (CMRT) or extended minerals reporting template (EMRT).
- That sourcing of 3TG and cobalt must be from SORs participating in third party audit programs aligned with OECD Due Diligence guidance and working toward certification.
- That action plans must be developed for SORs identified as not participating or certified to a third party audit program to remove them from the supply chain or have them participate in a program to obtain certification.

Structured work on identifying risk areas

The brand owner must carry out structured work to identify if at least 3TG and cobalt are present anywhere in the supply chain of the certified product, with the goal to identify the SORs. The verification of the structured work is carried out as part of the brand owner annual review process.

Identifying risk areas is a process that helps map the chain of custody of risk minerals down to the SORs within the supply chain. This is commonly done by a minerals reporting template being systematically sent through the supply chain. This transfer of information facilitates the identification of high-risk SORs.

Verification guidelines:

The verifier has been provided with a description of how the brand owner identifies risk areas in the supply chain of the certified product. The verifier can also require a copy of the completed minerals reporting template as further evidence of compliance. See the examples below:

- Using an established minerals reporting template as part of the brand owner's due diligence process. As a random follow-up at the request of TCO Development, completed examples of the template are to be submitted to the verifier.
- A public list of SORs on the brand owner website verifies that the brand owner has identified the list using a minerals reporting template.

Audited smelters or refiners (SORs)

Brand owners are required to annually submit information on the SORs identified as the source of 3TG and cobalt in the supply chain of the certified product. The required information identifies SORs that are conformant, active or otherwise registered through independent verification for their mineral sourcing due diligence process.

The brand owner must annually demonstrate the SORs that are conformant (certified) to an accepted responsible sourcing program and those that are considered to process scrap or recycled materials.

Verification guidelines:

The verifier must annually be provided with the responsible mineral sourcing template (a TCO Certified template) with the required columns covering information on the SORs identified as the source of 3TG and cobalt in the supply chains of the certified products.

The template section, 'Audited facilities' requires information about which SORs are in the supply chain of the certified product. SORs must be publicly registered as conformant with the Responsible Minerals Assurance Process (RMAP) or on the European Union (EU) 'white list'. Registered as 'active' or 'in-process' is not accepted as compliant. The verifier will compare the submitted information against the latest published list of conformant SORs using the comparison tool provided by TCO Development.

The brand owner can find their annual due date for submitting the responsible mineral sourcing template on TCO Certified Portal. The template is downloaded from tcocertified.com and must be submitted to the accepted verifier in time.

Audit program cross-recognition

RMAP cross-recognised audit programs are accepted. These presently include the London Bullion Market Association (LBMA) and the Responsible Jewellery Council (RJC). Other programs must first undergo independent verification to access the OECD due diligence guidance implementation before being accepted as an alternative. The brand owner must provide proof of alignment to the accepted verifier for assessment.

Due diligence program information:

- The OECD Due Diligence Guidance for Responsible Supply Chains of Minerals from Conflict-Affected and High-Risk Areas (“OECD due diligence guidance”), available at oecd.org. Brand owners require suppliers to disclose their sourcing origins of minerals using a questionnaire template such as the Responsible Minerals Initiative (RMI), conflict minerals reporting template (CMRT) or similar to prevent the potential use of risk minerals.
- Member of the Responsible Minerals Initiative (RMI). Members contribute to a number of tools and resources, including the conflict minerals reporting template, supporting in-region sourcing schemes and the Responsible Minerals Assurance Process (RMAP).
- Responsible Minerals Assurance Process (RMAP) helps companies make informed choices about responsibly sourced minerals in their supply chains. Independent third-party audits of SOR management systems and sourcing practices are used to validate conformance with RMAP standards. The assessment employs a risk-based approach to validate SOR company-level management processes for responsible mineral procurement.

The RMAP standards are developed to meet the OECD Due Diligence Guidance requirements, the Regulation (EU) 2017/821 of the European Parliament and the U.S. Dodd-Frank Wall Street Reform and Consumer Protection Act.

- EU ‘white list’ is a proposed list of SORs. The regulation (EU) 2017/821 promotes the responsible sourcing of SORs of tin, tantalum, tungsten and gold, whether they are based inside the EU or not. This is because EU importers must identify the SORs in their supply chains and check whether they have the correct due diligence practices. Whenever EU importers find SOR practices insufficient or associated with risks, they must manage and report on this.

To help companies, the European Commission is working to create a compliant list of global SORs which source responsibly.

2.5 Process chemicals management

Background

Scientific research shows that workers who come into contact with chemical substances used in the manufacture of IT products are more likely to suffer from cancer, reproductive damage, birth defects and other serious illnesses.

The use of chemicals such as benzene and n-hexane (industrial cleaning solvents), which have well-documented toxic human health effects, have been restricted in some parts of the world but are often used by the manufacturing industry in developing countries where legislation is weaker, and workers are less protected. These chemicals need to be phased out of production and not be replaced with equally hazardous substances.

To replace chemicals with safer alternatives, process chemicals and their suitable safer alternatives must be identified and independently assessed by an approved toxicologist. The Personal Protective Equipment (PPE), training and exposure monitoring provided to the workers who risk chemical exposure also need to be reviewed and improved.

Applicability

All product categories.

References

2.9, 2.10

2.5.1 Mandate

Each final assembly factory and factory manufacturing display panels >10" for the certified product:

- must have a structured health and safety management system independently certified to ISO 45001.
- must only use cleaning solvents for product components and PCB process cleaning that contain individual chemicals or formulations that appear on TCO Certified Accepted Substance List.
- must submit chemical inventory data covering at least cleaners, adhesives and lubricants.
- All substances of a mixture must be accounted for. Non-accepted substances must not exceed concentration levels of 0.1% by weight of the chemical product.

Submit the following to an approved verifier:

- A copy of the valid ISO 45001 certificate.
- An accepted process chemical data collection template. The chemical data must at least cover the chemical formulations and ingredients shown in the chemical safety data sheet and used on the production lines where certified products are manufactured. The template must be submitted before the factory is added to TCO Certified Portal.
- A completed and signed factory form (chapter 11.2).

The following is submitted to TCO Development:

- A copy of a verification report from a verifier approved by TCO Development.
- For assessed substances, a copy of the assessment report issued by an approved licensed profiler independent of the accepted screened chemistry program. For GreenScreen certified formulations, a copy of the GreenScreen Certified certificate is acceptable.
- The process chemical data template must be reported in TCO Certified Portal.

2.5.2 Clarification

The cleaning process chemicals that appear on TCO Certified Accepted Substance List are commonly used by production lines to clean display panels, product enclosures, printed circuit boards, SMT machinery and tools.

The production lines manufacturing certified products must only use cleaners listed on the TCO Certified Accepted Substance List. To be included on the list, chemicals must be independently assessed and receive a GreenScreen® benchmark score of 2, 3 or 4 or ChemFORWARD hazard band A, B or C. For chemical formulations, GreenScreen certified platinum or gold set by a licensed GreenScreen Profiler is accepted.

From the date when a factory is registered on TCO Certified Portal and TCO Certified Accepted Factory List, a 12-month transition period to using only safer alternatives appearing on TCO Certified Accepted Substance List can be applied for. To keep the factory active on TCO Certified Portal, an updated process chemical data collection template must be re-submitted before the process chemical compliance due date on TCO Certified Portal.

Proof of health and safety management system conformity:

A valid ISO 45001 certificate must be uploaded to TCO Certified Portal for each registered factory that is in scope of this requirement. The certificate must be issued by a certification body that is accredited to issue the certification. Factories that do not yet have a certified health and safety management system according to ISO 45001, may apply to TCO Development for an extended period of up to 24 months to complete certification. This extended-time application template can be obtained from an accepted verifier. TCO Development has the right to deny the applicant an extended period if there is reason to believe the factory cannot achieve the ISO 45001 certification within the period (for example, if other critical non-compliance issues are pending or if the factory has a history of persistent audit non-compliance).

Process Chemical Data Collection Tool and Guidelines

An accepted Process Chemical Data Collection Tool must be completed and uploaded to TCO Certified Portal. The data must cover at least cleaning agents, adhesives and lubricants used to produce the certified product. The Process Chemical Data Collection Tool can be downloaded from tco-certified.com/certification-documents.

Completing the Process Chemical Data Collection (PCDC) Tool

- The senior representative at the factory, whose responsibilities cover chemical management, must assist the applicant in completing the accepted PCDC Tool.
- The areas that must be completed by the applicant are listed as 'required'.
- Listed chemical substances must show the CAS# number. The chemical supplier can directly submit this information to TCO Development if there are proprietary concerns. If a CAS# number is withheld, the chemical ingredient is treated as a restricted substance, and the cleaning product must be replaced with an accepted alternative. An alternative is to have the formulation GreenScreen Certified and listed by trade name only.
- The information must cover at least all chemical types required under the mandate and used to manufacture certified products.
- Upon request, the process chemical inventory at the factory must also be submitted for independent verification purposes.
- The PCDC Tool must be updated at the request of TCO Development.
- TCO Development has the right to compile confidential information with CAS numbers. TCO Development reserves the right to publish such compiled, anonymous information. Still, no information will be presented so that the company or the products in question can be identified.

Exposure controls and personal protective equipment (PPE)

TCO Certified Accepted Substance List reduces the risk of worker exposure to highly hazardous chemicals. However, safer alternatives do not remove the responsibility of the factory management to provide personal protection equipment as described in the chemical's safety data sheet (SDS), which covers exposure controls and personal protection. Verification of PPE (availability, training and use) is included in the ISO45001 standard and as part of the required factory audits (see mandate 2.1).

3 Environmentally responsible manufacturing

- Large amounts of natural resources and energy are used to manufacture IT products.
- This consumption can lead to soil, water and air pollution, as well as large greenhouse gas emissions.
- To reduce environmental risk, the environmental impact must be measured and environmental and energy management systems need to be in place.

Major environmental risks in the IT industry

Several environmental hazards occur throughout the IT product life cycle. The manufacturing process is a large risk. Harmful substances that are not handled safely risk ending up in nature. Life cycle assessments confirm that a typical IT product consumes more energy during its manufacture than during its entire usable life, resulting in large greenhouse gas emissions which impacts our climate. Another risk is the extensive use of natural resources in manufacturing, leading to a high energy consumption and the loss of valuable, finite resources.

Our approach: measuring and incentivizing reduced environmental impact

With TCO Certified, the brand owner must have an environmental management system in place, and work systematically with continuous improvement in environmental performance. Gathering information on material reuse and energy efficiency in the assembly phase is important and creates incentives for reducing the product's carbon footprint.

Criteria in chapter 3 focus on:

- Lowering environmental risk and ensuring continual improvements by requiring that all final assembly factories are certified according to ISO 14001 and have an environmental management system in place.
- Putting the spotlight on energy efficiency in manufacturing through annual reporting.
- Lowering energy use in manufacturing by requiring compliance with ISO 50001.
- Gathering information about post-consumer recycled content and renewable materials to help buyers identify more circular products.
- Offering the brand owner an incentive to determine the product's carbon footprint through Product Carbon Footprint (PCF) analysis.

3.1 Environmental management system

Background

A certified environmental management system helps an organization work in a systematic way with environmental performance and make continuous environmental improvements. To be efficient, an environmental management system must include independent, external reviews.

Definitions

See definitions chapter 2.0

Applicability

All product categories.

References

2.11

3.1.1 Mandate

- Each final assembly factory and each factory manufacturing display panels >10" for the certified product must have a structured environmental management system that is independently certified to ISO 14001.

Submit the following to an approved verifier:

- A copy of a valid ISO 14001 certificate for each final assembly factory and each factory manufacturing panels >10" for the certified product.

The following is submitted to TCO Development:

- A copy of a verification report from a verifier approved by TCO Development.
-

3.1.2 Clarification

The applicant must ensure that a valid ISO 14001 certificate is available on TCO Certified Portal at all times, for every final assembly factory, and display panel factory that are registered to TCO Certified Portal as manufacturing certified products.

The certificate(s) or an appendix to the certificate(s) must make it clear what the certification covers.

If necessary the applicant may ask for an extended time period of up to 12 months on behalf of a factory that is not yet certified, by presenting a time plan for achieving the ISO 14001 certification and signing an agreement. TCO Development has the right to deny the applicant an extended period of time if there is a substantial risk that the factory will not be able to achieve ISO 14001 certification within the extended time period.

The certificate must be issued by a certification body that is accredited by an accreditation body covered by the International Accreditation Forum, iaf.nu, Multilateral Arrangement on Environmental Management Systems.

3.2 Renewable energy

Background

As we face the challenges posed by climate change, it has become increasingly important for companies to transition to renewable energy sources. By increasing the share of renewable electricity in the final assembly of certified products, the product carbon footprint and climate impact of the certified product are reduced. This also increases the demand for Renewable Energy Certificates (RECs), which increase the economic incentive to build new generators for renewable electricity in many regions where most electricity is generated from non-renewable sources.

Applicability

All product categories.

3.2.1 Mandate

At least 15% of the electricity used in the final assembly of the certified product must be procured and/or generated from renewable sources. This ratio must be reported yearly.

Submit the following to an approved verifier:

Once a year, the brand owner must provide:

- Documented proof of the ratio of renewable electricity used in the final assembly of the certified product in each factory that is used.
- Documented proof of the total electricity and the ratio of renewable electricity used in each final assembly factory of the certified product.

The following is submitted to TCO Development:

- A copy of the verification report(s) from a verifier approved by TCO Development.
 - The ratio of renewable electricity used in the final assembly of certified products for the brand in each factory must be reported in TCO Certified Portal once a year.
 - The total electricity consumption and the ratio of renewable electricity use for each final assembly factory must be reported in TCO Certified Portal once a year.
-

3.2.2 Clarification

Brand owner reporting period

The reporting by the brand owner must be submitted by 31 August each year. Each reporting period is the previous calendar year. The reporting applies until one year after the certificate has expired. Only electricity used and generated during the previous calendar year must be included in the report. Renewable electricity certificates may be procured up to three months after the reporting period as long as the applicable reporting period is specified on the REC (to avoid double counting).

Exception for new factories

For factories where no TCO Certified Generation 10 product was certified (for any brand) before 31 August. The brand owners manufacturing of certified products at this factory must be in compliance the following calendar year. However, the brand owner must still report the renewable electricity share of their manufacturing (even if not in compliance), each 31 August.

The ratio of renewable electricity may be reported at the factory or product level.

Brand owners can choose if to report on the whole factory level, or, on the manufacturing of their certified products. Reporting on their own manufacturing is useful if they want to purchase additional RECs for their own manufacturing to achieve a higher share than the factory.

In this case the electricity used to manufacture certified products is estimated based on the allocation of manufacturing volume, which is a common principle used in, for example, the Greenhouse Gas Protocol. This means that the total electricity consumption of the factory is allocated to individual products based on units manufactured.

For each reporting period and final assembly factory, the brand owner must report the following:

If the ratio of renewable electricity used by the factory is $\geq 15\%$ reporting may be done only on the factory level and must include:

- Documented proof of the total electricity consumption of the factory (X)
- Any RECs designated to the factory (with the factory name and region) for the renewable electricity (Y) generated or purchased by the factory during this period.

Calculations:

- The ratio of renewable electricity by the factory and in the assembly of certified products ($RF = (Y/X)$).

Otherwise, reporting must be more detailed and include:

- Documented proof of the total electricity consumption of the factory (X)
- Any RECs designated to the factory (with the factory name) for the renewable electricity generated or purchased by the factory during this period (Y).
- Documented proof of the total number of units of any kind manufactured (Z) and the number of certified units manufactured for the brand owner (W) during the period.
- Any RECs (S) designated to the factory and brand owner (with the factory name and brand name) specifically for the manufacturing of certified products.

Calculations:

- The estimated electricity used to manufacture certified products ($E = X/Z \cdot W$)
- The ratio of renewable electricity by the factory ($RF = Y/X$).
- The ratio of renewable electricity by the brand owners manufacturing ($RC = S/E$)
- The ratio of renewable electricity in the assembly of certified products ($RT = RF + RC$)

Exception for a high market price of RECs

If the market price of all allowed RECs in the market in question is above 10 USD / Mwh the applicant is allowed to source allowed I-REC accounting for 30% of the renewable electricity purchased from markets with neighboring borders.

If the market price of all allowed RECs in the market in question is above 30 USD / Mwh, the applicant is allowed to source allowed I-RECs accounting for 70% of the renewable electricity purchased from markets with neighboring borders.

Renewable electricity must be generated from:

- Wind,
- Solar,
- Geothermal,
- Hydropower (pumped hydro storage is not accepted)
- Biomass (agriculture waste and residues, forest biomass, biofuels plants)

Renewable energy certificates (RECs)

Renewable electricity can be purchased or generated. Factories can own their own projects. Projects might be on-site or off-site, on the grid, or entirely off-grid. The generation must be issued with renewable energy certificates (RECs). Factories can consume directly from their projects or retain the RECs, and claim the use of renewable electricity. They can also sell electricity to the grid, retain the RECs, and claim the use of renewable electricity.

Both for self-generation and market-purchased RECs the attributes (and certificates) must be sourced and purchased from within the same national region as the factory using the electricity. Also, the renewable electricity production facility for which the certificates are issued must be within the same national region. The national region constitutes a "market" for the purpose of transacting and claiming attributes. (see exception to this above).

A REC must be recognized on the list below to be accepted as proof of compliance. Credible systems may be added to the list after independent review and acceptance from TCO Development.

Country	Accepted REC
Brazil	I-REC
Canada	REC, I-REC
China	I-REC, GEC
Czech Republic	EECS-GO
Egypt	I-REC
Hungary	EECS-GO
India	I-REC, Indian national EAC system
Japan	J-Credit, FIT-NFC, GEC
Malaysia	I-REC
Mexico	I-REC
Poland	National Guarantees of Origin
Portugal	EECS-GO
Singapore	I-REC
Taiwan	T-REC, I-REC, CPPA
Thailand	I-REC
USA	REC, I-REC
Vietnam	I-REC
South Korea	Korean national EAC system

Verification guidelines of factory data

- Documented proof of the total electricity consumption consists of all electricity contracts and bills (The total number is added to the Accepted Factory List and only needs to be verified once per factory and year).
- Proof of the total number of units manufactured and the number of certified units manufactured for the brand owner (W) during the period must be a copy of a document or digital system that can be verified during an onsite audit. (The total number is added to the Accepted Factory List and only needs to be verified once per factory, brand name and year).

Verification of Renewable Energy Certificates (RECs)

The brand owner must present proof that renewable energy certificates are exclusively owned by, have been permanently retained by or retired on behalf of the specific factory or by the brand manufacturing at the specific factory. This means that RECs designated to the factory must have the factory name on it, and RECs designated to the brands manufacturing at the factory must have both the factory name, and brand name on it (to avoid double counting).

Energy Attribute Certificates are part of tracking systems in which certificates are electronically serialized and issued to generators with accounts on the system. There they are traded and ultimately permanently retired when they are used to support a claim.

For more information on how to verify the authenticity of the REC with each certificate body such as the below listed, a guideline can be found here:

<https://tcocertified.com/industry/certification-documents/>

Simplified verification process of RECs:

1. The authenticity of the REC is verified with each certificate body.
2. The reporting period is within the 12+3-month window.
3. The amount of renewable electricity represented by the certificate.
4. The certificate ownership is to the specific factory (and brand owner) in question.
5. The certificate is retired (not for sale) when making a claim about renewable energy.

3.3 Energy management system

Background

A certified energy management system helps an organization work in a systematic way with energy performance and make continuous improvements at both company and product levels. To be efficient, an energy management system must include independent, external reviews.

Definitions

See definitions chapter 2.0

Applicability

All product categories

3.3.1 Mandate

- Each final assembly factory and each factory manufacturing display panels >10" for the certified product must have a structured energy management system independently certified to ISO 50001.

Submit the following to an approved verifier:

- A copy of a valid ISO 50001 certificate for each final assembly factory and each factory manufacturing panels >10" for the certified product.

The following is submitted to TCO Development:

- A copy of a verification report from a verifier approved by TCO Development
-

3.3.2 Clarification

The applicant must ensure that a valid ISO 50001 certificate is available on TCO Certified Portal at all times for every final assembly factory and each factory manufacturing panels >10" for the certified product. The certificate(s) or an appendix to the certificate(s) must clarify what the certification covers.

Factories that do not yet have a certified energy management system according to ISO 50001, may apply to TCO Development for an extended period of 24 months to complete certification by annually submitting an extension application on the certification status. This application and status template can be obtained from TCO Development.

TCO Development has the right to deny the applicant an extended period if there is a substantial risk that the factory will not be able to achieve ISO 50001 certification within the extended period. The certificate must be issued by a certification body accredited by an accreditation body covered by the International Accreditation Forum, iaf.nu, Multilateral Arrangement on Energy Management Systems

3.4 Post-consumer recycled content

Background

Use of recycled materials lowers the environmental impact. The manufacturing of recycled plastics, if 100% recycled content is achieved, can reduce energy consumption by up to 60 percent, compared to virgin plastics. Less raw materials are required to produce recycled plastics, which can lead to a reduced carbon footprint. Every metric ton of recycled plastic produced can result in up to 1-3 metric tons of carbon dioxide savings, compared to virgin plastics.

The long-term goal is that all materials in certified products are circulated and renewable where technically possible.

Definition

PCR – Post-consumer recycled: Post-consumer recycled materials are derived from used consumer products, often packaging, bottles and durable goods including IT products. (I.e. aluminum cans, PET bottles). This does not include PCM material.

PCM - "Pre-consumer Material": Material or by-products generated during the manufacturing of a product but before the product reaches the end-use consumer.

Applicability

All product categories.

3.4.1 Mandate

The following information for the worst-case configuration (lowest PCR content ratio) of the certified product (including any external power supply) must be reported:

- Percentage of post-consumer recycled plastics by weight versus the total weight of all plastics.
- Percentage of identified post-consumer recycled materials (plastic and non-plastic) by weight versus the product weight.

Submit the following to an approved verifier:

- The completed post-consumer recycled content template
- Supporting documentation for all parts claiming PCR content.
- A completed and signed product form (chapter 11.3).

The following is submitted to TCO Development:

- A copy of the verification report(s) from a verifier approved by TCO Development.
- Supporting documentation for all parts claiming PCR content.

The following is submitted to TCO Development and may be published:

- The total product weight (including external power supply) and configuration
- The weight of all plastics in the product.
- The weight of all post-consumer recycled plastics and other identified post-consumer recycled material in the product.

3.4.2 Clarification

The worst-case configuration (lowest PCR content by weight of total product weight) that is available for purchase must be defined and stated in the verification report. It must be defined through a unique brand owner code, a unique product identifier, or a list of configuration choices that are available at the time of purchase. *If there are several versions of the same component (e.g. due to different suppliers) and the buyer cannot influence which version they get, then the worst-case version of the component must be reported.)*

All plastic parts with a weight above 0.5 grams must be accounted for in the Post-consumer recycled content & packaging template. Parts that are non-plastic and without PCR content do not need to be listed individually.

Document proof from an independent third party covering each part containing post-consumer recycled material must be provided if it is to be included in the PCR percentage. TCO Development has the right to require a full bill of material.

Exceptions plastics

Optical components and display panels, electronic components, cables, connectors, PCBs, insulating mylar sheets, hard sheets for insulation, soft sheets for heat dissipation, elastomer feet, sponge materials, and labels may be excluded. This means that the weight of these items is not included when calculating the total weight of the plastic in the product in this requirement. The total product weight for the worst case configuration is calculated including these parts.

The following information must be submitted to an approved verifier

For each plastic part with a weight above 0.5g, the following must be reported:

- Name of part/part ID
- Material manufacturer name
- Identification marking of PCR material
- Weight of part (grams)
- Weight of plastics in part
- Weight of post-consumer recycled content (grams)

For other identified post-consumer recycled content:

- Name of part/part ID
- Material manufacturer name
- Type of material
- Weight of part (grams)
- Weight of post-consumer recycled content (grams)

The post-consumer recycled content template is available at tcocertified.com/certification-documents and may be used to provide this information. Similar templates covering the same information are acceptable.

3.5 Product carbon footprint

Background

Product Carbon Footprint (PCF) is one of the most established ways of determining the climate impact of a product. PCFs cover the whole life cycle of a product, from the raw material extraction to the recycling or disposal phase. Using product carbon footprints enables an overall picture in order to work on reductions and measures in the right places.

Applicability

All product categories.

3.5.1 Mandate

A PCF must exist for each certified product, and its availability must be evaluated by an approved verifier.

Submit the following to an approved verifier:

- Necessary documentation for the evaluation of PCF availability
- A completed and signed product form (11.3).

The following is submitted to TCO Development:

- A copy of the verification report(s) from a verifier approved by TCO Development.

The following is submitted to TCO Development and may be published:

- Type of PCF availability must be reported in TCO Certified Portal.
- Instructions on how to retrieve the PCF.

3.5.2 Clarification

The PCF for the product is estimated based on product type data using either ISO 14040, ISO 14044, ISO 14067, ISO 14025, IEC TR 62921, PAS 2050, the WRI GHG Protocol Product Life Cycle Accounting and Reporting Standard, PAIA-tool, INEMI Eco-Impact Estimator or equivalent PCF standard.

For product models that can be configured, the PCF for the product must at least be based on the product model family.

PCF Requirements

The product carbon footprint result must include the following:

1. Inputs used in the assessment (at a minimum, lifetime of the product, amount of electricity consumed in the use phase by the product per year, and significant product model elements/parameters).
2. Total life cycle carbon footprint and carbon footprint of the product's life cycle stages (at a minimum, manufacturing, use, transport, and end-of-life).
3. Explanation of uncertainty addressed either through a statistical assessment or through a disclaimer statement.

Availability

The availability of PCF increases the transparency of PCF methods used and enables future revisions.

Publicly available

- The results of the PCF as defined in the PCF Requirements are publicly available and can be downloaded free of charge.
- A link to the download location is uploaded to TCO Certified Portal

Available on-demand

- The results of the PCF as defined in the PCF Requirements are available on-demand from the brand owner.
- Instructions on how to retrieve the PCF is provided.

Verification guideline

In order to determine if a PCF can be considered as publicly available, the verifier must:

1. Confirm that the PCF is available for download free of charge on the brand owners PCF repository
or
2. Confirm a public statement on the brand owner's website, that at least all TCO Certified products will have the results of the PCF available online during product availability.

3.6 Product carbon footprint reductions

Background

Research conducted by IT sustainability research and consulting organization PX3, on 707 unique IT product models from 42 manufacturers shows that many manufacturers report no PCF value at all for several of their products. And for products that report PCF values, different manufacturers have chosen different methods to make the calculations. Add to this the complexity of the supply chain. This means that comparisons of PCF between products are more or less meaningless, and to draw correct conclusions from the comparisons and make sustainability-focused purchasing strategies based on these values meaningless also, and possibly even misleading.

One way to overcome this, until all manufacturers publish comparable and verified PCF values, is to look at average scope 3 calculations for different product types and instead focus on activities reducing product carbon footprint. In order to incentivize reductions of the carbon footprint, a list of accepted best practice solutions is included in TCO Certified and expanded over time. The implementation of any solution on this list is then verified by independent experts and may be published by TCO Development as an estimated reduction of the Px3 value representing the product's carbon footprint.

Applicability

All product categories.

3.6.1 Mandate

A comparable product carbon footprint value must be estimated for the certified product according to the Px3 methodology with any implemented reductions subtracted.

Submit the following to an approved verifier:

- Documented proof of the implementation of any claimed PCF reduction solution covering the manufacturing of the certified product.

The following is submitted to TCO Development:

- A copy of the verification report(s) from a verifier approved by TCO Development.
- All verified PCF reduction solutions, the period when the reduction is valid, and the total estimated reduction of the PCF must be reported in TCO Certified Portal.

The following is submitted to TCO Development and may be published:

- All verified PCF reduction solutions implemented and the total estimated reduction of the PCF.
-

3.6.2 Clarification

The Px3 values estimated for certified products make comparisons between products possible. This enables sustainability-focused purchasing strategies. For products where no

reduction solution has been implemented, the default Px3 value (without any reduction) will be used for the certified product.

Claiming a reduction of the Px3 value

To claim a best practice solution on the list, a brand owner must provide documented proof of implementation of the solution covering the production of the certified product.

Adding new best practices to the list

Other solutions may be added as they get accepted by TCO Development. A description of the solution is then sent to an approved independent expert who will determine if the solution fulfills the requirements or not. To qualify for the list of best practices, the investigation must show that the proposed best practice solution:

- contributes to a measurable reduction of the total PCF that can be estimated as a reduction of the Px3 value.
- is possible to verify in a credible way
- is not already industry standard but instead pushes the majority of brand owners to improve their supply chains.
- is formulated so that it is not limited to a certain brand owner or proprietary technology.

All the supporting documentation and the conclusion from the expert are then sent to TCO Development, who will decide to update the list of best practices solutions.

Px3 value and list of best practice solutions to reduce the PCF

The Px3 value is the average product carbon footprint estimation that will be presented when no reduction solutions have been implemented. The list of best practice solutions that are accepted and will result in a reduction of the estimated PX3 value in the TCO Certified Product Finder can be found at: <https://tcocertified.com/industry/certification-documents/>

4 User health and safety

- A poorly designed IT product may cause discomfort and cause injury and health problems for the user.
- Fire hazard, electric shock and explosions are some of the risks associated with substandard products. They may also have a short lifespan which is negative from a sustainability perspective.
- A safe and ergonomically designed IT product supports productivity and can meet the user's needs longer.

Poor product design is a safety hazard

Product safety and functionality is fundamental to sustainability in the IT sector. Products that are uncomfortable or unsafe to use often have a short lifespan which leads to pollution, e-waste and high resource consumption. They may also cause health and safety problems for the user. Examples of identified safety hazards include product overheating and risk of fire, battery volatility which can lead to burning or explosion, and poor electrical safety design that may increase the risk of fire or electric shock.

Our approach: verifying product safety, protecting the user

An IT product must be safe to use and should provide the user with the necessary function and comfort for a long time. To be efficient, criteria for user health and safety aspects must be specific, and tailored to each product category.

Criteria in chapter 4 focus on:

- Requiring that products are safe to use and that the user's risk of injury is minimized.
- Making sure that any cases of burning, explosion and electric shock are prevented.
- Limiting specific risks through criteria adapted for each product category.

4.1 Electrical safety

Background

IT products must be safe to use. Electrical safety refers to the electrical design of the product. Electrical insulation and other arrangements must be in place to prevent the user from touching live components. Faulty or inadequate electrical insulation can also result in an electrical flashover that may cause a fire or an explosion.

Applicability

All products with built-in or external power supplies.

References

4.1.

4.1.1 Mandate

The product and external power supply/supplies must be certified according to IEC 62368-1 edition 2 or newer.

Submit the following to an approved verifier:

- A copy of a valid CB certificate for the product.

The following is submitted to TCO Development:

- A copy of the verification report(s) from a verifier approved by TCO Development.
-

4.1.2 Clarification

For products classified as medical equipment, IEC 60601-1 version 3.2 or newer can be used instead of IEC 62368-1.

4.2 Acoustic noise

Background

Acoustic noise from fans, disk drives, etc. can be disturbing to users. Therefore, IT products should be as silent as possible during use. To make it possible for the user to choose a product with a comfortable noise level and frequency characteristics, this information should be reported.

To provide comparable information about acoustic noise levels, the A-weighted sound power level (L_{WAd}) in operating and idling mode must be measured in accordance with ISO 7779:2018 and reported in accordance with ISO 9296 p.4.4.1 in bels (B). As these standards do not include any clear definition of operating and idling mode, the following definitions apply for these modes and for the reported sound values:

Definitions

Sound power level (L_w): Total emitted sound power from a sound source, given in bels (B) and with the reference 1 pW.

A-weighting: The measured linear sound level (sound pressure or sound power) weighted against the sensitivity of the human ear for different frequencies (A-curve).

Declared A-weighted sound power level (L_{WAd}): in bels (B). Defined in accordance with ISO 9296 3.2.5.

Operating mode(s): A condition in which the system must be operated, at a load equal to or higher than "Web browsing" & "Office productivity" for personal computers and workstations defined in ECMA-74 20th edition (C.15.3).

Idling mode: A condition in which the system must be operated, at a load equal to or higher than "idling mode" for personal computers and workstations defined in ECMA-74 edition 20 (C.15.3).

Applicability

All notebook computers and tablets with integrated moving parts.

References

4.2-4.8

4.2.1 Mandate

1. The A-weighted sound power level (LWAd) must not exceed:

Operating mode: 3.9B
Idling mode: 3.5B

If the product does not emit prominent discrete tones according to procedures specified in ECMA 74 Annex D, a higher A-weighted sound power level (LWAd) is accepted but must not exceed:

Operating mode: 4.2B
Idling mode: 3.8B

2. The A-weighted sound power level for a product must be reported in the product data sheet and/or in any other product descriptions.

Submit the following to an approved verifier:

- A copy of the test report(s) from a laboratory accredited according to ISO 17025
- A completed and signed product form (chapter 11.3)

The following is submitted to TCO Development:

- A copy of the test report(s), and a copy of the verification report(s) from a verifier approved by TCO Development.

The following is submitted to TCO Development and may be published:

- The A-weighted sound power level must be reported in TCO Certified Portal.

4.2.2 Clarification

The acoustic noise test must only be carried out if the product has any internal moving mechanical parts. This noise measurement is to be carried out at any test facility accredited according to ISO 17025, but the test report must be verified by a verification organization approved by TCO Development, who must sign a verification document for noise, covering all configurations.

Prior to testing, the computer must have been switched on for 15 minutes. Switch on the computer and begin recording elapsed time starting immediately after completing any log in activity necessary to fully boot the system. Once logged in with the operating system fully loaded and ready, close any open windows so that the standard operational desktop screen or equivalent ready screen is displayed. Exactly 15 minutes after this, run the sample in accordance with ECMA-74 20th edition (or a more recent version) and start to accumulate test noise levels.

The required operating modes for testing are “Web browsing” & “Office productivity”. The worst case value of these two modes should be reported.

The PC Mark "Web Browsing" test under "Essentials" may be used for the "Web browsing" operating mode.

The PC Mark "Writing" and "Spreadsheets" may be used for the "Office productivity" operating mode. If SYSMark is used, this mode it is called "Productivity"

For Chromebook systems, PCMark for Android can be used by choosing "Web Browsing 3.0" for "Web Browsing" and "Writing 3.0" together with "Data Manipulation 3.0" may be used for the "Office productivity" operating mode.

The noise measurements must follow ISO 7779:2018 or a more recent version fo the standard and must be reported according to ISO 9296:1988. (However, the principle for how the measurement uncertainty is handled must be the same as for all the other criteria in the certification. This means that no uncertainty must be added to the result presented in the report.)

In addition to reporting the measured A-weighted sound power level (L_{WA}) in Bels (B), the single measurement values of the 9 measurement positions and the mean value of these A-weighted sound pressure level (L_{pA}) in decibels (dB) must be included in the test report.

Overall uncertainty

The test must be performed in such a way that the total expanded uncertainty in the test result will be less than ± 2.5 dB.

Note

The uncertainties given are worst case limits. In many cases it will be possible to obtain better accuracy.

5 Product performance

- A low-performing product can reduce user productivity and satisfaction. It may therefore be discarded prematurely.
- High energy consumption can lead to large emissions of greenhouse gases, which contributes to the climate crisis.
- By taking both product performance and environmental factors into account, user productivity can improve and the device can be in use for a longer time.

Low product performance reduces productivity and is a sustainability risk

Product performance is essential for user satisfaction and productivity. Low-performing products are also problematic from a sustainability perspective – in many cases, these products have a shorter lifespan, which leads to pollution, e-waste and high resource consumption. Discarding products prematurely is often also more costly for the purchasing organization.

Our approach: balancing product performance with energy efficiency

Product performance, user satisfaction and the development of more circular IT products are interconnected. In order for IT products to be more sustainable, all these factors need to be prioritized. Balancing product performance with energy efficiency is also important to reduce the product's climate impact.

High-performance products can meet the user's needs for a longer period of time. This way, the product's service life can be extended, which is an extremely important factor in reducing resource consumption, reducing greenhouse gas emissions and the amount of e-waste produced. Using the product for a longer time is also often better from an economic perspective, and provides a lower total cost of ownership for the purchasing organization.

Criteria in chapter 5 focus on:

- Requiring that product performance is balanced with energy efficiency through specific criteria for each product category.

5.1 Energy efficiency

Background

The IT industry and people's IT usage are large sources of greenhouse gas emissions, which remain the leading factor in climate change. As the number of IT equipment in use grows, greenhouse gas emissions are also increasing. Reducing the problem requires a number of measures, of which energy-efficient products are one part.

This criterion focuses on energy efficiency in the use phase and helps purchasing organizations independently verify that the IT product they source meets the energy efficiency requirements of ENERGY STAR.

Applicability

Notebooks, tablets,

References

5.1.

5.1.1 Mandate

The energy consumption and power supply requirements in version 8 of the ENERGY STAR® program for computers must be fulfilled.

Submit the following to an approved verifier:

- A copy of the test report(s) from a laboratory accredited according to ISO 17025.

The following is submitted to TCO Development:

- A copy of the test report(s), and a copy of the verification report(s) from a verifier approved by TCO Development.

The following is submitted to TCO Development and may be published:

- The measured energy values and product configuration must be reported in TCO Certified Portal

5.1.2 Clarification

The product must be tested according to version 8 (or a more recent version) of the ENERGY STAR program for computers. Testing can be carried out at any test facility accredited according to ISO 17025, but the test report must be verified by a verification organization approved by TCO Development. The minimum version of EnergyStar that all product configurations are able to meet will be presented on the certificate.

Testing only needs to cover the energy consumption requirements and the power supply requirements of that program. The product does not need to be ENERGY STAR certified to be approved for TCO Certified.

Measured energy consumption according to ENERGY STAR®, as well as Typical Energy Consumption (TEC) and the allowed maximum consumption (TEC_MAX) for each category

(I1-I2, D1-D2, O-2 or Thin Clients) must be submitted to TCO Certified Portal, together with the application.

For each tested configuration, at least the following properties must be reported on the test report and in TCO Certified Portal:

- Processor brand
- Processor model
- System memory (GB)
- Integrated or dedicated GPU
- Operating system name
- PSU if applicable

Exceptions and special requirements

All exceptions and special requirements, test methods etc. that are accepted by ENERGY STAR are also accepted by TCO Development.

Products that are covered by another ENERGY STAR product specification must be tested according to that specification.

Visual ergonomics

Good visual ergonomics is a very important aspect of quality that can also have a direct effect on the health, comfort and productivity of the user. Good ergonomics, such as a high quality display image, can also influence our productivity and extend the usable life of a product. In this way, ergonomic design can also offer sustainability benefits.

In developing criteria for visual ergonomics, the possible health effects of various parameters have been taken into account. Other features that characterise high quality displays have also been in focus when developing these criteria.

TCO Development used three main methodologies to determine suitable levels and test methods for the visual ergonomics criteria:

1. Acceptable visual levels, as determined by scientific research.
2. Statistics from tests carried out in accordance with TCO Development, ISO, MPR regulations and from specialized VDU tests.
3. Manufacturers' knowledge and experience, which is invaluable. Manufacturers, consumer groups and other organisations with interests in the visual ergonomics field have contributed a great deal of valuable information and ideas throughout the development process.

5.2 Display resolution

Background

Image quality is negatively affected by a low fill factor, visible “jaggies”, poor rendering of details. All of these are related to the resolution of the display. For display resolution characteristics, it is important to take the viewing distance into account.

Definition

A pixel is the smallest addressable imaging element of the display panel capable of reproducing a full range of luminance and colors.

Applicability

Notebooks.

References

5.4.

5.2.1 Mandate

The display panel should have a pixel density of at least 100 PPI.

The following is submitted to TCO Development:

- A copy of the test report(s), and a copy of the verification report(s) from a verifier approved by TCO Development.

The following is submitted to TCO Development and may be published:

- The pixel density must be reported in TCO Certified Portal.
-

5.2.2 Clarification

100 PPI gives a reasonable image quality at a viewing distance of 55cm, which can be regarded as a normal viewing distance to a notebook computer placed on a table, based on anthropometric data. As the notebook display is attached to the keyboard, the viewing distance is linked to the reach of the notebook keyboard.

Preparations for testing

No specific preparation of the product is needed.

Equipment

Calibrated ruler for the diagonal measurement. Product manual or similar information about the display resolution.

Test method

The maximum resolution and size of the display panel are found in the manual or similar information from the manufacturer. Verify the diagonal distance in inches rounded to one decimal and calculate the PPI.

Test evaluation

The pixel density (PPI, pixels per inch) should be calculated as following:

$$PPI = \frac{\sqrt{\text{horizontal pixels}^2 + \text{vertical pixels}^2}}{\text{the diagonal of the panel in inches}}$$

Overall uncertainty

Measurement uncertainty in diagonal measurement is $\leq \pm 2\text{mm}$. Product data information is sufficient.

See 9.1.

Draft 2

5.3 Correlated color temperature

Background

Physical measurements of color stimuli can only give an indication of the color appearance in a practical situation. The color of the frame, the spectral composition of the lighting, the color of various areas in the visual field, and the complexity of brightness variations in the visual field all influence the color appearance of a notebook display image.

It is important to be able to set a color temperature that represents average daylight. It will be intuitive to most users to have their document background and photo editing in this color temperature as this is a light source that users will be exposed to daily. Average atmospheric filtered daylight has a correlated color temperature of approximately 6500K and is reproduced by a number of standards ex. D65, sRGB, ITU rec 709 which are widely used in photo and video editing.

Definition

The correlated color temperature is a measure of the perceived screen color expressed in Kelvin (K).

Applicability

Non monochromatic notebooks with backlit or light emitting pixels.

References

5.4, 5.15-5.18, 5.21, 5.23-5.29, 5.30, 5.31.

5.3.1 Mandate

The product default preset correlated color temperature may have any name but must have a color difference $\Delta u'v' \leq 0.02$ when compared to CIE u' and v' chromaticity coordinates for D65.

The following is submitted to TCO Development:

- A copy of the test report(s), and a copy of the verification report(s) from a verifier approved by TCO Development.
 - The measured values must be reported in TCO Certified Portal.
-

5.3.2 Clarification

Preparations for testing

- All necessary preparations described in 9.1 and 9.3 must be done.
- A TCO Certified default test image, as shown in figure 9.1.7, must be used for this measurement.

Equipment

Spectro-radiometer capable of presenting CIE u' and v' chromaticity coordinates with at least three decimals.

Test method

The spectral properties at the center of the measurement area must be measured with a spectroradiometer. The spectral data must then be processed, which is normally done directly in the instrument's microprocessor, to give chromaticity coordinates. In this case, the CIE coordinates u' and v' are needed for the test evaluation and are often presented directly by the spectro-radiometer used.

Test evaluation

CIE $u'v'$ chromaticity coordinates for D65.

u'	v'
0,1979	0,4683

If the spectro-radiometer used only can produce CIE 1931 x and y chromaticity coordinates, these can be transformed to u' and v' chromaticity coordinates by using the formulae in the CIE Publication 15.2 (reference 5.17). The relevant CIE material – conversion formulae and tabulated data for u'_{cct} and v'_{cct} – can also be found on tcocertified.com.

The resulting color difference calculation must be presented to 3 decimal places.

Overall uncertainty

$\leq \pm 0.003$ in u' and v' .

See 9.1.

5.4 Color gamut

Background

Accurate color rendering is important when realistic color images or color presentations are presented on the notebook display. Poor color rendering can lead to poor readability and misinterpretation.

Applicability

Non monochromatic notebooks with backlit or light emitting pixels.

References

5.15-5.18, 5.21, 5.23-27, 5.29-5.33.

5.4.1 Mandate

The minimum color triangle must have the following coordinates:

	Red		Green		Blue	
Coordinate	u'	v'	u'	v'	u'	v'
Requirement	≥ 0.375	≥ 0.503	≤ 0.160	≥ 0.548	≥ 0.135	≤ 0.305

The following is submitted to TCO Development:

- A copy of the test report(s), and a copy of the verification report(s) from a verifier approved by TCO Development.
- The measured values must be reported in TCO Certified Portal.

5.4.2 Clarification

The u' and v' chromaticity coordinates of the primary colors red (R), green (G) and blue (B) of the screen must aim at values given in international IEC, EBU and ITU standards. The u' and v' chromaticity coordinates of the primary colors R, G and B form a triangle in the CIE 1976 uniform chromaticity scale diagram. The larger the area of the triangle, the wider the range of colors the screen is capable of presenting.

Preparations for testing

- All necessary preparations described in 9.1 and 9.3 must be done.
- A TCO Certified default test image, as shown in figure 9.1.7, must be used for this measurement.
- The measurement area must have each of the following RGB settings: (255, 0, 0) for red, (0, 255, 0) for green, (0, 0, 255) for blue.

Equipment

Spectro-radiometer with a capacity to present u' and v' coordinates to at least 3 decimal points.

Test method

The instrument must be directed orthogonally towards the different test square centers at the measurement distance described in 9.3.5. Measure the chromaticity coordinates at the center of the measurement area for each color setting specified above or alternatively, the larger measurement area image (80% of the active screen area) described in 9.1.7 may be used for these measurements. Change the color of the area for each measurement.

Test evaluation

The recorded chromaticity coordinates u' and v' for the red, green and blue squares must be reported.

The u' and v' must be presented to 3 decimal places.

Overall uncertainty

$\leq \pm 0.003$ in u' and v' for red and green.

$\leq \pm 0.007$ in u' and v' for blue.

See 9.1.

5.5 Color uniformity

Background

The human visual system is very sensitive to changes in color hue in white and gray areas. White and gray color hues also serve as reference colors on the screen that affect how all other colors are perceived. Patches of color variation on an active white or gray screen may reduce the contrast, be disturbing and affect readability, color rendering and color differentiation.

Definition

The color uniformity of a display is the capability to maintain the same color on any part of the screen.

Applicability

Non monochromatic notebooks with backlit or light emitting pixels.

References

5.4, 5.14, 5.16-5.19, 5.20, 5.21.

5.5.1 Mandate

The maximum color deviation between measured active areas on the screen that are intended to maintain the same color must be $\Delta u'v' \leq 0.012$.

The following is submitted to TCO Development:

- A copy of the test report(s), and a copy of the verification report(s) from a verifier approved by TCO Development.
- The measured value must be reported to TCO Certified Portal.

5.5.2 Clarification

Preparations for testing

- All necessary preparations described in 9.1 and 9.3 must be done.
- The entire active area of the screen must be white and the display color setting must be RGB 255, 255, 255.

Equipment

Spectroradiometer with a capacity to present u' and v' coordinates with at least 3 decimals.

Test method

The color uniformity must be measured orthogonally to the notebook screen plane at nine points. The four corner positions (1, 3, 7 and 9) are measured 1° from the edges of the screen as shown in *luminance uniformity 1*. The four side positions (2, 4, 6 and 8) are measured on the middle of the side 1° from the edge. These measurement points have a $1/2^\circ$ margin to the edges if the measurement area of the instrument is 1° (see figure *luminance uniformity 1*). Finally the center position (5) is measured.

The color uniformity must also be evaluated visually by the technician in order to find those areas where the color varies the most except from the nine default positions. If a significant difference within the 1° from the edge area is found these measuring points must also be measured and used to evaluate the color uniformity. The conditions for color measurement in the corner positions and the distribution of other measurement points are illustrated in figure *luminance uniformity 1*.

Test evaluation

$\Delta u'v'$ according to the CIE (1976) uniform chromaticity scale diagram must be calculated for each measured position using the formula

$$\Delta u'v' = \sqrt{(u'_A - u'_B)^2 + (v'_A - v'_B)^2}$$

where A and B are the two points found to have the largest color difference between them.

The largest difference in $u'v'$ value must be reported.

The result must be presented to 3 decimal places.

The evaluation procedure is exemplified below:

- Make a table of color chromaticity values for each measured position

Measurement position no.	u'	v'
1	0.190	0.447
2	0.186	0.441
3	0.186	0.437
-	-	-
n-1	0.185	0.434
n	0.186	0.432
Largest difference	0.005 in this example	0.015 in this example

- The largest u' difference, $\Delta u'$, is 0.005 (between 0.190 and 0.185) at measurement positions 1 and n-1.
- The largest v' difference, $\Delta v'$, is 0.015 (between 0.447 and 0.432) at measurement positions 1 and n.
- Since $\Delta v'$ (= 0.015) is much larger than $\Delta u'$ (= 0.005), the $\Delta v'$ value must be used for the calculation of $\Delta u'v'$.
- The corresponding two pairs of u' and v' to be used for the calculation are thus the values found at position 1 and position n and thus become the values used for points A and B such that $u'_1 = u'_A = 0.190$ and $v'_1 = v'_A = 0.447$ for point A in this example and $u'_n = u'_B = 0.186$ and $v'_n = v'_B = 0.432$ for point B in this example

Hence $\Delta u'v' = \sqrt{0.000016 + 0.000225} = 0.01552$, which must be reported as 0.016.

Overall uncertainty

$\leq \pm 0.003$ in u' and v' .

See 9.1.

Draft 2

5.6 Color uniformity – angular dependence

Background

The human visual system is very sensitive to changes in color hue in white and grey areas. White and gray color hues also serve as reference colors on the screen that affect how all other colors are perceived. Angular-dependent color variations on an active white or grey screen could be disturbing and affect readability, color rendering and color differentiation.

Definition

The white color uniformity – angular dependence of a display is the capability of the display to maintain constant white color over the screen surface depending on the direction from which the screen is viewed.

Applicability

Non monochromatic notebooks with backlit or light emitting pixels.

References

5.4, 5.14, 5.16-5.21.

5.6.1 Mandate

In landscape mode, the $\Delta u'v'$ between areas on the left side and the right side of the screen when it is positioned at $+15^\circ$ and at -15° horizontally to the screen normal (rotated around the vertical axis through the center of the screen) must be ≤ 0.025 .

The following is submitted to TCO Development:

- A copy of the test report(s), and a copy of the verification report(s) from a verifier approved by TCO Development.
 - The measured value must be reported to TCO Certified Portal.
-

5.6.2 Clarification

Preparations for testing

- All necessary preparations described in 9.1 and 9.3 must be done.
- The screen background must be RGB 102,102,102.
- Chromaticity coordinates u' and v' must be measured at three different positions on the screen as shown in figure *color uniformity - angular dependence 1*. Each measurement position must consist of white RGB 255, 255, 255 areas with a size that is 4% of the active screen size.
- The spectro-radiometer must be positioned and directed orthogonally to the screen center-point as described in 9.3.5.

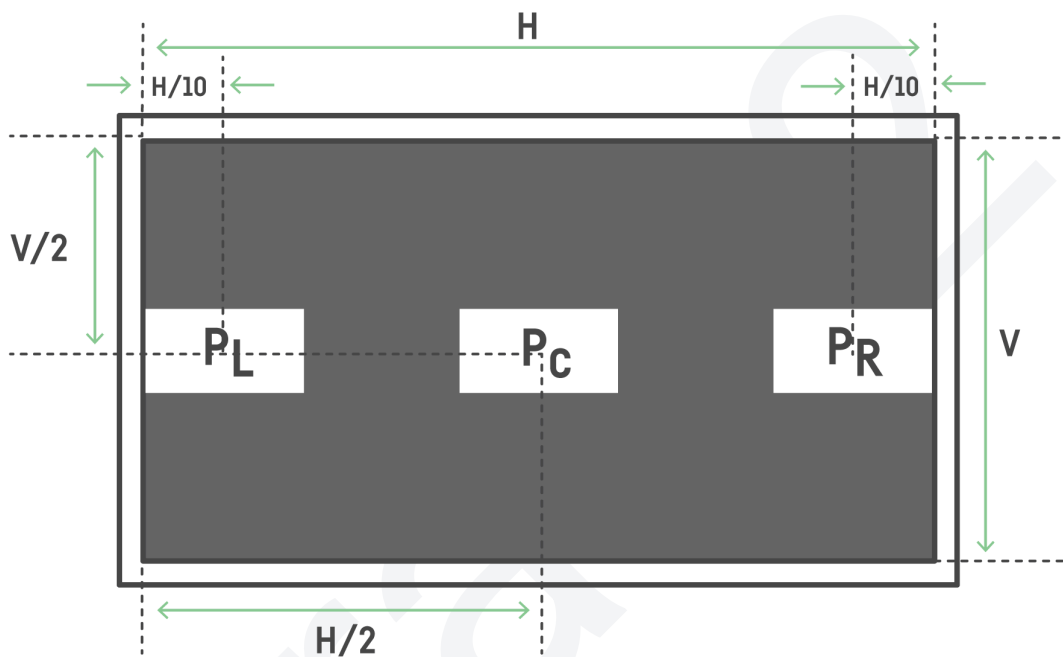

Figure *color uniformity - angular dependence 1*. Measurement positions for color uniformity-angular dependence.

Equipment

Spectro-radiometer with a capacity to present u' and v' coordinates with at least 3 decimals.

Test method

- The spectro-radiometer must always be directed towards a measurement point and rotated around a fixed vertical axis, (or horizontal axis for the tilt measurement) through the focal point of the front lens with a distance as described in 9.3.5.
- The spectro-radiometer must be turned towards positions P_L and P_R and focused. The color coordinates at positions P_L and P_R ($u'_{P_L/0}$, $v'_{P_L/0}$ and $u'_{P_R/0}$, $v'_{P_R/0}$ respectively) must be recorded.
- The screen must then be rotated $+15^\circ$ around a vertical axis through the screen centre-point and the chromaticity coordinates at positions P_L , P_R , ($u'_{P_L/+15}$, $v'_{P_L/+15}$ and $u'_{P_R/+15}$, $v'_{P_R/+15}$ respectively) must be recorded.
- The screen must finally be rotated -15° around a vertical axis through the screen centre-point and the chromaticity coordinates at positions P_L , P_R , ($u'_{P_L/-15}$, $v'_{P_L/-15}$ and $u'_{P_R/-15}$, $v'_{P_R/-15}$ respectively) must be recorded.

- Pivot screens must only be measured in the normal landscape mode.

Test evaluation

$\Delta u'v'$ according to the CIE (1976) uniform chromaticity scale diagram must be calculated for each measured position using the formula

$$\Delta u'v' = \sqrt{(u'_A - u'_B)^2 + (v'_A - v'_B)^2}$$

where A and B are the two points found to have the largest color difference between them.

The largest difference in $u'v'$ value must be reported.

The result must be presented to 3 decimal places.

The evaluation procedure is exemplified below:

- Make a table of chromaticity values for each measurement position and calculate $\Delta u'v'$ for +15° for and -15°

Measurement position no.	Example value u'	Example value v'
PL /+15	0.190	0.447
PR /+15	0.187	0.442
Difference at +15°	0.003	0.005
$\Delta u'v'$ at +15°	0.0059	
Measurement position no.	Example value u'	Example value v'
PL /-15	0.182	0.436
PR /-15	0.189	0.432
Difference at -15°	0.007	0.004
$\Delta u'v'$ at -15°	0.0081	
Largest difference $\Delta u'v'$	0.0081 in this example	

The largest calculated $\Delta u'v'$ difference is 0.0081 when the screen is rotated -15°. The test value to be reported is this value, reported to 3 decimal places, thus 0.008.

Overall uncertainty

≤ ± 10% in luminance.

≤ ± 0.003 units for u' and v' .

≤ ± 0.3° in rotation angle.

See 9.1.

5.7 Color grayscale linearity

Background

A well-tuned color grayscale is the basis for good color rendering on the screen. This is measured via steps in a grayscale on the screen. To enable correct color interpretation, each grayscale step should have similar color hues. To avoid confusion for the user, only the luminance should vary.

Definition

Color grayscale linearity is the capability of the screen to maintain the same u',v' coordinates of a grayscale pattern at all grayscale levels. Only the luminance should change from one grayscale step to the next.

Applicability

Non monochromatic notebooks with backlit or light emitting pixels.

References

5.4, 5.14, 5.16-5.21.

5.7.1 Mandate

The $\Delta u'v' \leq$ the maximum allowed difference for each step according to table *color grayscale linearity 1*.

Table *color grayscale linearity 1*.

	Maximum $\Delta u'v'$ difference					
Greyscale	255	225	195	165	135	105
255	0					
225	0,045	0				
195	0,045	0,045	0			
165	0,050	0,050	0,050	0		
135	0,055	0,055	0,050	0,050	0	
105	0,055	0,055	0,055	0,055	0,050	0

The following is submitted to TCO Development:

- A copy of the test report(s), and a copy of the verification report(s) from a verifier approved by TCO Development.
- The largest $\Delta u'v'$ measurement must be reported in TCO Certified Portal.

5.7.2 Clarification

Preparations for testing

- All necessary preparations described in 9.1 and 9.3 must be done.
- A TCO Certified default test image, as shown in figure 9.1.7, must be used for this measurement.
- The measurement area must have a size that is 4% of the active screen size and have the following RGB settings: R=G=B= 255, 225, 195, 165, 135, 105, 75, 45.

Equipment

Spectroradiometer with a capacity to present u' and v' coordinates with at least 3 decimals.

Test method

The instrument must be directed orthogonally towards the different measurement areas centers at the measurement distance described in 9.2.5. Measure the chromaticity coordinates at the center of the measuring area for each grayscale step specified above. Change the grayscale of the area for each measurement.

Test evaluation

The evaluation procedure is exemplified below:

- A spreadsheet is available on tcocertified.com, which will calculate the $\Delta u'v'$ differences between all the grayscale levels according to the equation:

$$\Delta u'v' = \sqrt{(u'_A - u'_B)^2 + (v'_A - v'_B)^2}$$

- Fill in the chromaticity values of u' and v' for each measured grayscale step into the corresponding cells of the spreadsheet.
- The table *color grayscale linearity 1* contains colored cells indicating difference requirements. The principle is that the darker the grayscale the more difficult it is to see a color difference.
- Examples on how to use the table: By using the column 255 (grayscale 255) and go down to line 165 (grayscale 165) you find that the maximum allowed color difference $\Delta u'v'$ is 0.050 (orange cell). For the grayscales 225 and 105 the maximum allowed difference is 0.055 (blue cell).

Overall uncertainty

$\leq \pm 10\%$ in luminance.

$\leq \pm 0.003$ units for u' and v' .

See 9.1.

5.8 Luminance level

Background

Poor screen luminance can lead to low contrast, poor readability and color discrimination, which may cause misinterpretations and eye strain. Therefore, it is important that the luminance levels can be set both high and low enough, with respect to the ambient lighting.

Definition

Luminance being emitted from a particular area is a measure of the luminous intensity per unit area of light travelling in a given direction and falls within a given solid angle.

The unit of luminance is candela per square meter (cd/m^2).

Applicability

Notebooks with backlit or light emitting pixels.

References

5.3- 5.8.

5.8.1 Mandate

The maximum luminance must be $\geq 150 \text{ cd}/\text{m}^2$.

The following is submitted to TCO Development:

- A copy of the test report(s), and a copy of the verification report(s) from a verifier approved by TCO Development.
- The maximum luminance must be reported to TCO Certified Portal

5.8.2 Clarification

Preparations for testing

- All necessary preparations described in 9.1 and 9.3 must be done.
- The product must be unplugged from mains before testing.
- The TCO Certified default test image with an 18-step grayscale as shown in Figure *Luminance level 1* must be used for luminance level measurement.

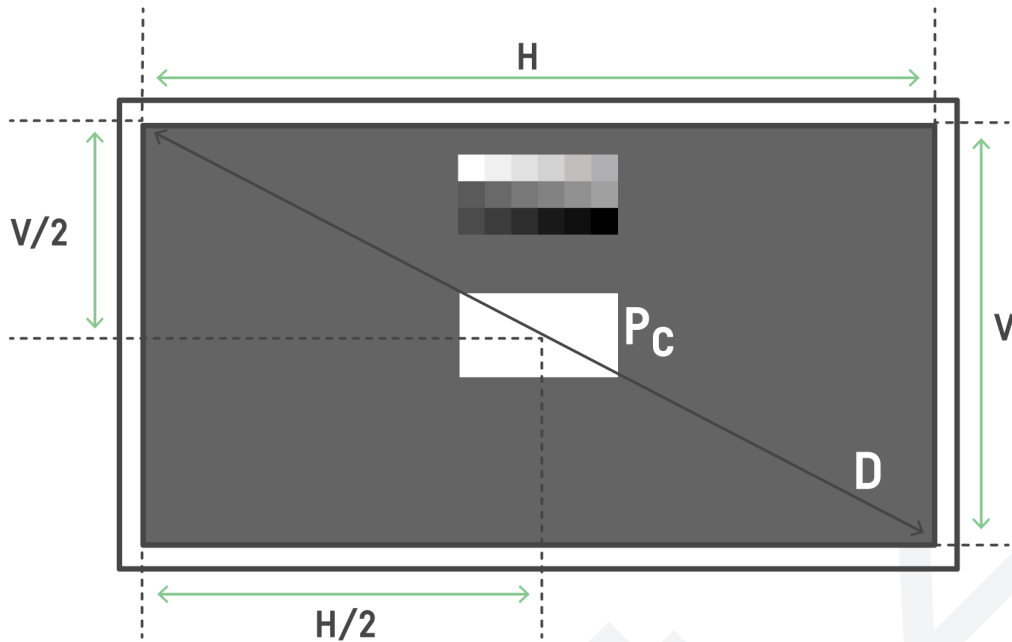

Figure *Luminance level 1*. The TCO Certified default test image with the 18-step grayscale inserted.

- The measurement position P_C must be at the center of the measurement area without line borders, having an RGB setting of 255, 255, 255, and positioned at the center of the screen. The background must be RGB 102,102,102.

The following evaluation must be carried out orthogonally to the screen surface:

- To achieve the maximum luminance proceed as follows:
Use the TCO Certified default test image with an 18-step grey scale pattern presented on the screen. From the default setting, adjust the controls for the display to achieve as high luminance as possible with an acceptable image quality. The image quality is considered acceptable when at least 15 of the 18 grayscale steps are visible. At this maximum luminance, test that the display has a luminance $\geq 150 \text{ cd/m}^2$.
- When this test is completed the display must be adjusted back to the test luminance setting as described under 9.1.7 for all remaining Visual Ergonomic tests. Allow the display to stabilize before other test measurements are made.

Equipment

Luminance meter or spectroradiometer.

Test method

The luminance at the center of the white test area must be measured with the luminance meter directed orthogonally to the test area as described in 9.3.5. For the battery mode measurement, the battery must be fully charged. Disconnect the power supply and wait about 5 minutes to have the screen stabilized before the measurement of the luminance is performed. Re-connect the power supply after the Battery mode test is completed.

Test evaluation

The measured luminance is the required value. The luminance must be reported with no decimal places.

The measured Luminance, Contrast and Brightness settings must be noted in the test report. The preset CCT in default setting must also be noted.

Overall uncertainty

$\leq \pm 10\%$ in luminance.

See 9.1.

Draft 2

5.9 Luminance uniformity

Background

Poor luminance uniformity can locally affect the contrast and consequently the readability of information on the display. The areas of deviating luminance can have different sizes and cause varying contour sharpness.

Definition

Luminance uniformity is the capacity of the notebook display to maintain the same luminance level over the whole active screen area. The luminance uniformity is defined as the ratio of maximum to minimum luminance within the fully active screen area.

Applicability

Notebooks with backlit or light emitting pixels..

References

5.3-5.7, 5.9-5.12.

5.9.1 Mandate

Luminance variation across the active screen, $L_{\max} : L_{\min}$ must be ≤ 1.60 .

The following is submitted to TCO Development:

- A copy of the test report(s), and a copy of the verification report(s) from a verifier approved by TCO Development.
- The luminance variation must be reported to TCO Certified Portal

5.9.2 Clarification

Preparations for testing

- All necessary preparations described in 9.1 and 9.3 must be done.
- The entire active area of the screen must be white and the display color setting must be RGB 255, 255, 255.

Equipment

Luminance meter or spectroradiometer.

Test method

The luminance must be measured orthogonally to the notebook screen plane at nine points. The four corner positions (1, 3, 7 and 9) are measured 1° from the edges of the screen as shown in figure *luminance uniformity 1*. The four side positions (2, 4, 6 and 8) are measured on the middle of the side 1° from the edge. Finally the center position (5) is measured. This means that all measurement points have $1/2^\circ$ marginal to the edges if the measurement area of the instrument is 1° .

The luminance uniformity must also be evaluated visually by the technician in order to find any dark or bright areas except from the 9 default positions. If a significantly bright or dark area is found these measuring points must also be measured and used to evaluate the luminance uniformity.

The conditions for luminance measurement in the corner positions and the distribution of other measurement points are illustrated in figure *luminance uniformity 1*.

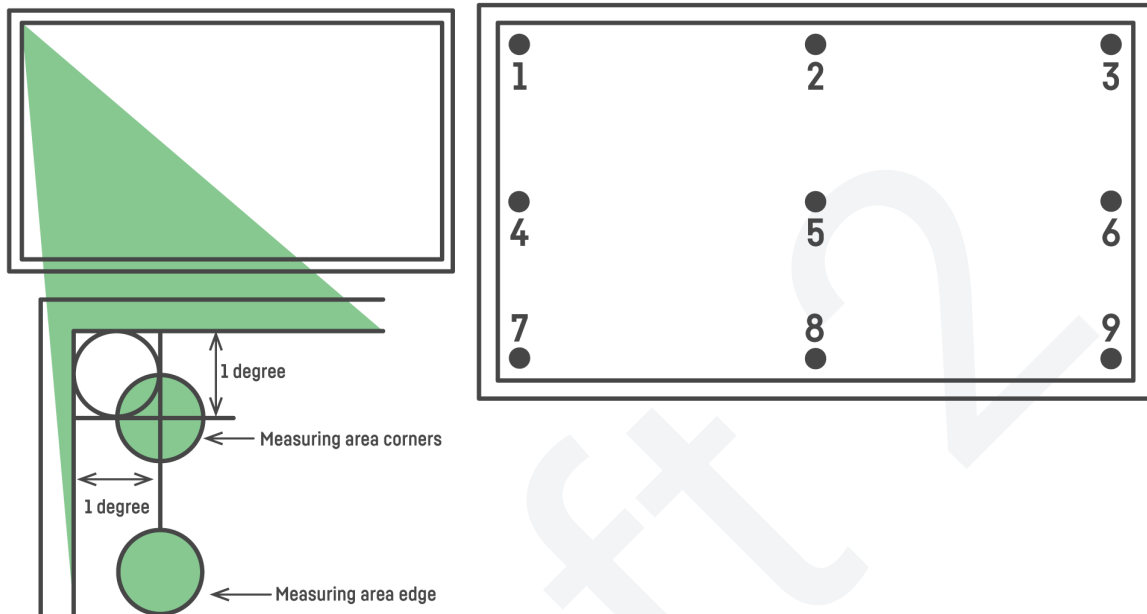

Figure *luminance uniformity 1*. Measurement positions for the measurement of luminance and color uniformity.

Test evaluation

The luminance uniformity must be reported as the ratio between the highest and the lowest measured luminance values.

The result must be presented to 2 decimal places.

Overall uncertainty

$\leq \pm 10\%$ in luminance.

$\leq \pm 0.1$ unit in luminance uniformity.

See 9.1.

5.10 Luminance uniformity - angular-dependence

Background

The luminance of a display may be angular-dependent which means that screen luminance decreases when the display is viewed slightly from the side, either horizontally or vertically. This can have a negative effect on contrast and can affect the readability of the display.

Definition

Luminance uniformity – angular dependence, is the capacity of a display to maintain a certain luminance level irrespective of the viewing direction. The angular-dependent luminance uniformity is defined as the ratio of maximum luminance to minimum luminance in the specified measurement areas.

Applicability

Notebooks with backlit or light emitting pixels.

References

5.3, 5.7, 5.9-5.12.

5.10.1 Mandate

In landscape mode, when the screen is rotated around the vertical axis through the center of the screen the mean value of the L_{\max} to L_{\min} ratios at $\pm 15^\circ$ must be ≤ 3.00 .

The following is submitted to TCO Development:

A copy of the test report(s), and a copy of the verification report(s) from a verifier approved by TCO Development.

5.10.2 Clarification

Preparations for testing

- All necessary preparations described in 9.1 and 9.3 must be done.
- Luminance values must be measured at five different positions on the screen as shown in figure *luminance uniformity - angular-dependence* 1. Each measurement position must consist of white RGB 255, 255, 255 measurement areas (4% of the active screen size) without line borders.
- The background must be RGB 102,102,102.
- The luminance meter must be positioned and directed orthogonally to the screen center-point as described in 9.3.5

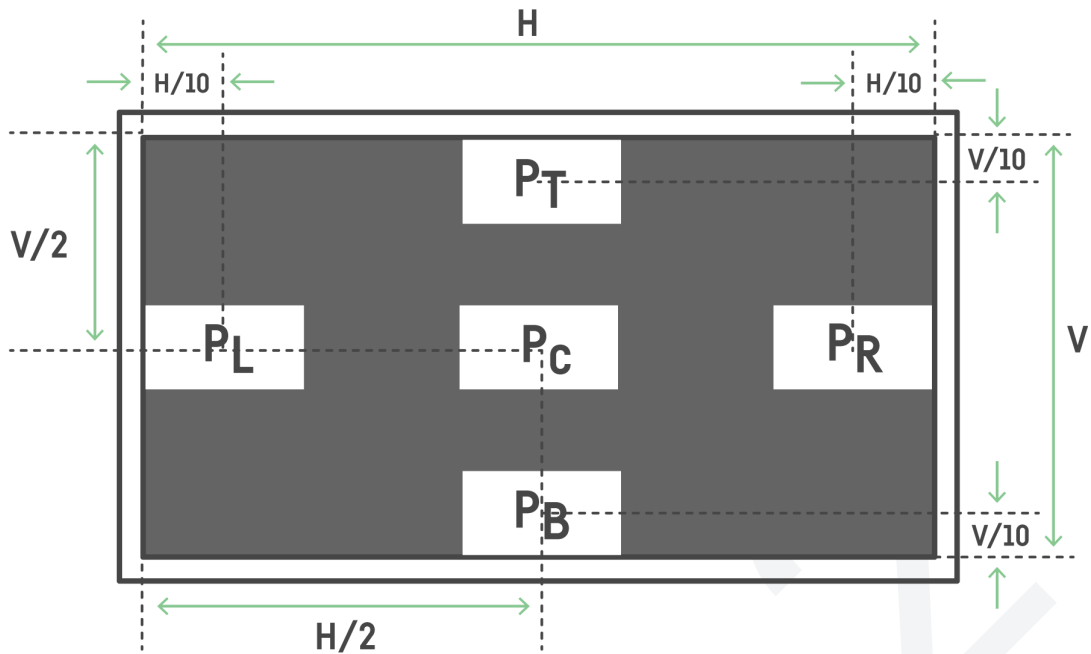

Figure: *luminance uniformity - angular-dependence 1*. Measurement positions for luminance uniformity - angular dependence.

Equipment

Luminance meter.

Test method

1. The luminance meter must always be directed towards a measurement point and rotated around a fixed vertical axis (or horizontal axis for the tilt measurements) through the focal point of its front lens at the distance described in 9.2.5.
2. In landscape mode the display must be rotated +15 degrees around a vertical axis through the display center-point and the luminance at positions P_L and P_R ($L_{P_L/+15/0}$ and $L_{P_R/+15/0}$ respectively) must be recorded. See figure *luminance uniformity - angular-dependence 2*
3. In landscape mode the display must then be rotated -15 degrees around the vertical axis through the screen center-point and the luminance at positions P_L and P_R ($L_{P_L/-15/0}$ and $L_{P_R/-15/0}$ respectively) must be recorded. See figure *luminance uniformity - angular-dependence 2*.
4. In landscape mode the display must then be tilted +15 degrees backwards around a horizontal axis through the display center-point and the luminance at positions P_T and P_B ($L_{P_T/0/+15}$ and $L_{P_B/0/+15}$ respectively) must be measured. This is not mandated but the result must be recorded for reference reading in the test report. See figure *luminance uniformity - angular-dependence 3*.
5. In landscape mode the display must then be tilted -15 degrees around a horizontal axis through the display center-point and the luminance at positions P_T and P_B ($L_{P_T/0/-15}$ and $L_{P_B/0/-15}$ respectively) must be measured. This is not mandated but the result must be recorded for reference reading in the test report. See figure *luminance uniformity - angular-dependence 3*.

6. The measurements to be carried out are summarised in table *luminance uniformity - angular-dependence 4*. The step numbers in the step column are the test method paragraphs.

Table *luminance uniformity - angular-dependence 4*.

Steps	Landscape mode	Screen rotation	Screen tilt	Measuring points			
				P _L	P _R	P _T	P _B
Step 2	Horizontal direction (turned around vertical axis)	+15°	0°	X	X		
Step 3	Horizontal direction (turned around vertical axis)	-15°	0°	X	X		
Step 4	Backwards tilt = (turned around the horizontal axis)	0°	+15°			X	X
Step 5	Forwards tilt = (turned around the horizontal axis)	0°	-15°			X	X

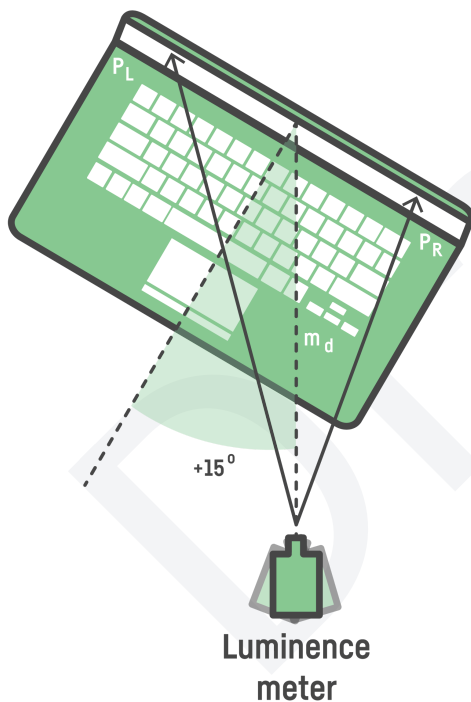

Figure *luminance uniformity - angular-dependence 2*. Top view of test set-up when the display is rotated ± 15 degrees. The + rotation is defined clockwise.

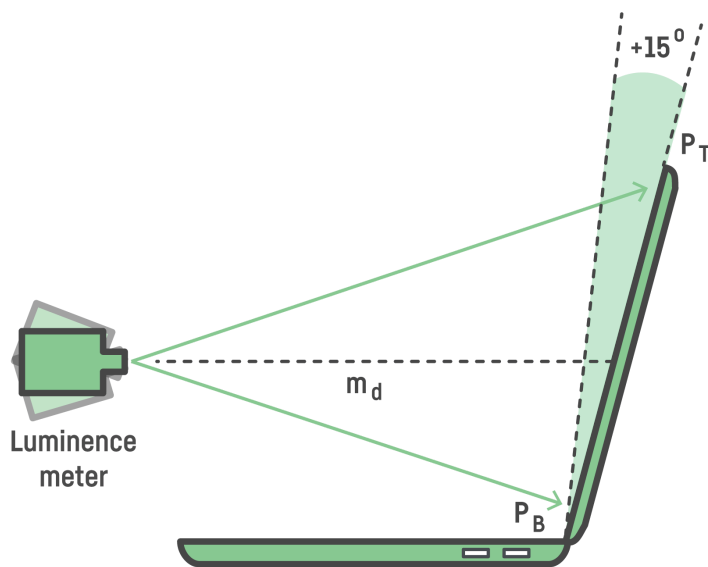

Figure *luminance uniformity - angular-dependence 3*. Side view of the test set-up when the display is tilted +15° backwards.

Test evaluation

The luminance uniformity for angular dependence must be calculated as follows:

- In landscape mode, for the horizontal direction, (turned around the vertical axis) measurement presented in table *luminance uniformity - angular-dependence 4* (test step 2 and 3). A ratio between the two measured luminances must be calculated. This ratio, or its inverse if it has a higher value, must be reported as the requested L_{\max} to L_{\min} luminance uniformity in mandate 1. The requirement is on the mean value of the two ratios +15° and -15°. The result must be presented to 2 decimal places.

Tilt test results are required to be given in the report:

In landscape mode, for the vertical direction (turned around the horizontal axis). Tilt backwards and tilt forwards $\pm 15^\circ$ (test steps 4 and 5 above). A ratio between the two measured luminances must be calculated. Both the +15° and -15° ratios must be in the test report as the requested L_{\max} to L_{\min} luminance uniformity and be presented to 2 decimal points.

Overall uncertainty

$\leq \pm 10\%$ in luminance.

$\leq \pm 0.3^\circ$ in rotation angle.

$\leq \pm 0.1$ unit in luminance uniformity.

See 9.1

5.11 Luminance contrast – characters

Background

The degree of contrast is important for readability and for distinguishing one character from another.

Definition

Luminance contrast – characters is the capacity of the display to maintain a high luminance difference between a bright background and dark characters or parts of characters over the whole active area.

Luminance contrast – characters is expressed as the ratio of the L_{\max} to L_{\min} difference over the sum of L_{\max} and L_{\min} , in accordance with Michaelson's formula.

Applicability

Notebooks with backlit or light emitting pixels.

References

5.4, 5.7, 5.9, 5.10, 5.11, 5.14, 5.22.

5.11.1 Mandate

The luminance contrast must be ≥ 0.70 measured orthogonally to the screen.

The following is submitted to TCO Development:

- A copy of the test report(s), and a copy of the verification report(s) from a verifier approved by TCO Development.
- The luminance contrast must be reported in TCO Certified Portal.

5.11.2 Clarification

Preparations for testing

- All necessary preparations described in 9.1 and 9.3 must be done.
- A micro-photometer for luminance measurement must be aligned orthogonally to the display surface.
- The test images must be presented in a pixel matched way. One program that does this up to 8-bit color is Microsoft Paint.

Equipment

A micro-luminance meter such as an array photodetector capable of measuring luminance on structures ≤ 0.02 mm. Measurement requirements are given in clause 9.3.2.

Test method

This measurement is a modified version of the measurements in IDMS 7.2 and IDMS 7.8. By visual evaluation of the standard test measurement position the technician must search for and locate visual stripes, or patches, that clearly influence the contrast of characters or

even parts of characters. Once the patches are visually identified as having significantly lower contrast they must be geometrically referenced from the upper left corner of the active image and the position must be reported in the test report. If no such position is found, the default test position is the center of the screen. If one position is found that does not fulfil the mandate, there is no need to make further measurements.

With an array or scanning light measuring device, obtain the luminance profile of the vertical black-pixel line and the corresponding white region. Obtain the net signal S as a function of distance with any background subtracted (this is the background inherent in the detector if a nonzero signal exists for no light input). A correction for veiling glare must be made. See the figure below for an illustration of the pixel configuration and data. 12 consecutive pixel rows on the display must be used for integration in vertical direction to get a one-dimensional intensity signal.

Here, the 1-1-1-1 patterns must be used, i.e. the 6-groups with the highest resolution. Inside each group, the pattern with the worst measured performance must be chosen. Perform a running window average (moving box-car filter) of the luminance profile where the averaging window width is as close as possible to the pixel pitch as rendered by the light measuring device. There should be at least 10 or more detector pixels per display pixel. For example, if an array detector is used and with the magnification of the imaging lens there are 53.4 array pixels which cover the display pixel pitch, then the running average window width is 53 array pixels wide. From the resulting modulation curve determine (1) the net intensity level of the vertical black line

$S_k = S_d - S_g$, where S_d is the minimum intensity level (dim) of the black line generated by the display, S_g is the ground level, and (2) the net intensity level of the white line $S_w = S_h - S_g$, where S_h is the maximum intensity level (high) of the white line generated by the display. Compute the resolution contrast ratio as, $C = (S_w - S_k) / (S_w + S_k)$.

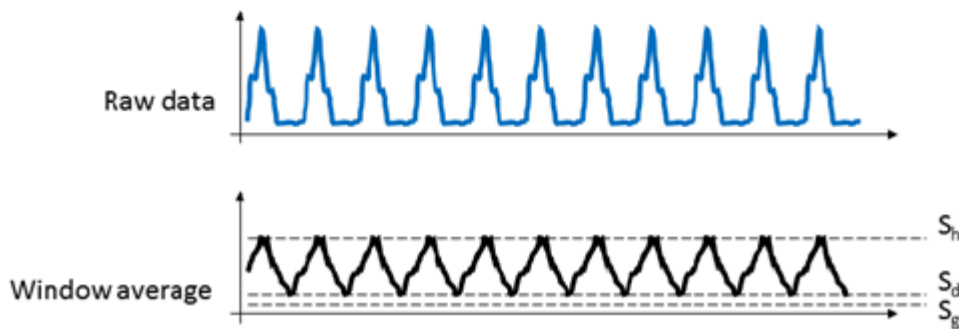
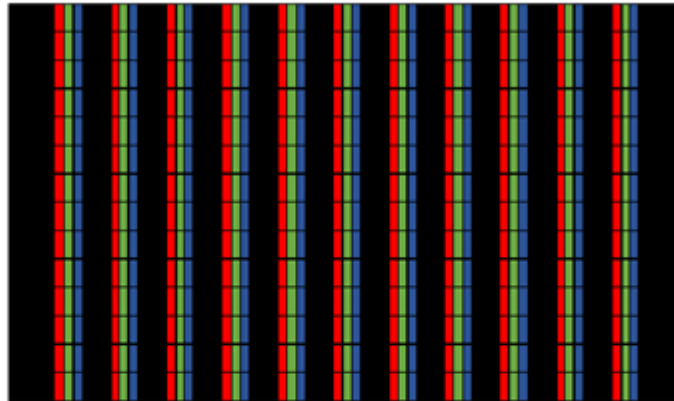

Figure *Luminance contrast - characters 1*: Measurement principle (from IDMS 7.2).

In summary:

$$S_K = S_d - S_g \quad (1)$$

$$S_W = S_h - S_g \quad (2)$$

$$C = (S_W - S_K) / (S_W + S_K)$$

Then perform the same operation but in vertical mode for the other set of grille patterns.

Record the contrast values for both directions.

Test picture: "WGrille pattern" with the same resolution as the display.

Test evaluation

C must be ≥ 0.70 .

The lowest luminance contrast found must be reported.

The result must be presented to 2 decimal places.

Overall uncertainty

$\leq \pm 0.05$ in contrast.

The misalignment between the screen surface normal and the optical axis of the luminance meter must be $\leq 0.3^\circ$.

See 9.1.

5.12 Luminance contrast - angular dependence

Background

For displays, the luminance and consequently the contrast of the display may be angular-dependent. The luminance variations can influence both the bright white and the dark areas of the screen, causing a change in contrast. This can have a negative effect on the readability of the display.

Definition

Luminance contrast – angular dependence, is the capability of the Notebook display to maintain the same contrast regardless of the direction from which the screen is viewed. Luminance contrast – angular dependence, is expressed as the ratio of the L_{\max} to L_{\min} difference over the sum of L_{\max} and L_{\min} , in accordance with Michaelson's formula. It is measured at two different angles.

Applicability

Notebooks with backlit or light emitting pixels.

References

5.4, 5.9, 5.12-5.15.

5.12.1 Mandate

In landscape mode, the luminance contrast-angular dependence must be ≥ 0.80 at $\pm 15^\circ$ horizontally from the viewing direction (rotated around the vertical axis through the center of the screen).

The following is submitted to TCO Development:

- A copy of the test report(s), and a copy of the verification report(s) from a verifier approved by TCO Development.
 - The luminance contrast-angular dependence must be reported in TCO Certified Portal.
-

5.12.2 Clarification

Preparations for testing

- All necessary preparations described in 9.1 and 9.3 must be done.
- A TCO Certified default test image, as shown in figure 9.1.7, must be used for this measurement.
- The measurement area must have each of the following RGB settings: (RGB 255, 255, 255) and (RGB 0, 0, 0).

Equipment

Luminance meter or spectroradiometer.

Test method

- The luminance meter must be positioned and directed orthogonally to the screen center-point as described in 9.3.5.

- The notebook computer display must be rotated around a vertical axis through the screen front center, changing the azimuth angle to + 15°. The luminance of the white measurement area L_{W+15} and the luminance when the measurement area is black L_{K+15} at the center must be recorded.
- Finally the azimuth angle of the screen must be changed to -15° and the new measurements $L_{W/-15}$ and $L_{K/-15}$ taken.

Test evaluation

The luminance contrast values C_{+15} and C_{-15} must be calculated using the formula

$$C = \frac{L_W - L_K}{L_W + L_K}$$

Of C_{+15} and C_{-15} , only the lowest value must be reported as the luminance contrast.

Overall uncertainty

≤ ± 10% in luminance.

≤ ± 0.05 in contrast.

See 9.1.

5.13 Keyboard gloss

Background

Keyboard gloss influences visual comfort and readability by drawing attention away from the visual task at hand. The higher the gloss value, the more likely it is that the surface will create irritating specular reflections (mirror-like reflections) from ambient lighting. If the gloss value is high enough, a problem of reflection images may occur.

Definition

Gloss is a measure of how a light beam, physically described as luminous flux, is scattered at the surface when incident against that surface. Gloss is a function of the directional reflectance properties of a surface.

Applicability

Notebooks.

References

5.50-5.52.

5.13.1 Mandate

The gloss of the keyboard (keys) must have a gloss value $G(60^\circ) \leq 30$ gloss units.

The following is submitted to TCO Development:

A copy of the verification report(s) from a verifier approved by TCO Development.

5.13.2 Clarification

Preparations for testing

- No special preparation of the notebook computer is needed.
- The notebook keyboard must be clean.
- A gloss measurement instrument needs an absolutely flat surface to function properly.
- If the keyboard of the notebook computer is curved, a measurement could be made elsewhere on the housing, provided that the measured surface microstructure, texture and colour are identical.
- If no absolutely flat test surface can be found on the keyboard surface, then the manufacturer must also supply a flat piece of material with optical properties fully equivalent to the keyboard material.

Equipment

A gloss meter in accordance with ISO 2813, ASTM D 523 or DIN 67 530 and a calibrated reference standard.

The measurement of gloss must be made using an instrument with an incident light beam angle of 60° to the normal of the measured surface.

Test method

Measurement of gloss must be made at several locations on the notebook keyboard bezel which is in the line of sight of the user. Measurements must also be made on the keyboard keys. Logos, brand names, type marks, control buttons, cameras and other small markings are excluded from the measurements and the requirements.

Test evaluation

A gloss result must be presented in gloss units with no decimal places.

The highest recorded gloss value must be reported.

Overall uncertainty

$\leq \pm 2$ gloss units.

Draft 2

6 Product lifetime extension

- In our current, linear way of producing and consuming products we take virgin natural resources and make products from them which we then discard once we're done using them – often after a relatively short time.
- Linearity leads to the loss of valuable and scarce natural resources, pollution and extensive energy use that contributes to the climate crisis.
- Moving toward sustainable solutions means creating a system that is more regenerative, where products and materials are kept in their intended use longer.

Linearity undermines ecosystems and the economy

Today, the common approach to the IT product life cycle is linear. Virgin materials are extracted to make new products which are used and then discarded, often after a relatively short time. In a majority of cases, materials are not recycled, and turn to waste. This linear “take, make, use, dispose” model is not sustainable and largely inefficient from a resource perspective. It depletes the earth's natural resources, and creates enormous amounts of hazardous e-waste.

Our approach: driving the development of products that can live longer

The best way to begin taking a more circular approach to the production and consumption of IT products, is extending their usable life. For the IT industry, this means designing products that are durable, built to last, upgradeable and repairable, making them more attractive for reuse or secondary markets. Once a product has reached the end of its usable life, the materials should be possible to recycle and use again in new products.

Criteria in chapter 6 focus on:

- Extending product life by requiring that products are durable, repairable and that spare parts and repair manuals are available.
- Making sure batteries in mobile products live longer, are replaceable and easily can be charged in a way that protects the battery from premature degradation.
- Enabling reuse of cables and reducing e-waste through requirements of standardized connectors.
- Incentivizing the IT industry to produce longer-lasting products by requiring that a product warranty must be in place on all markets where the product is sold.
- Preventing data leakage and promoting safe reselling of products through secure data removal solutions.

6.1 Product warranty

Background

A precondition for an extended product lifetime is that the product is of high quality. A product warranty provides the brand owner with an economic incentive to design a durable product that lasts longer and to encourage users to keep their products longer before replacing them.

Definitions

Brand owner: The company or organization owning or controlling the brand name.

Brand name: The name or sign, including but not limited to a trademark or company name, used to identify, amongst users and customers, the manufacturer or seller of a product.

Product warranty: Covers defects existing at the time of delivery and those appearing after delivery that are due to material or manufacturing faults. It does not cover damages due to misuse or accidents. *(However, functionality defects resulting from normal wear and tear, such as battery degradation, fan and keyboard wear-down, etc. must be covered.)*

MSRP: Manufacturer's suggested retail price

Applicability

All product categories.

6.1.1 Mandate

In all markets where the product is sold, the brand owner must:

- Offer a 5-year minimum available warranty, where at least 1 year must be included free of charge.
- Each year of warranty, which is not included free of charge, must be offered for a maximum of 15% of the MSRP of the product and must be available for purchase together with the product.

Submit the following to an approved verifier:

- A link to a public statement in English covering the warranty of the certified product.
- A completed and signed brand owner product form (chapter 11.4).

The following is submitted to TCO Development:

- A copy of the verification report(s) from a verifier approved by TCO Development.

The following is submitted to TCO Development and may be published:

- Minimum included product warranty in years
 - Minimum purchasable extended warranty in years
 - Minimum total available warranty in years (free + extended)
 - The maximum cost (in % of product cost) per year for the extended warranty
 - A link to a public commitment on warranty covering the certified product
-

6.1.2 Clarification

The brand owner must provide a link to a public statement in English covering the certified product, where the brand owner commits to the minimum warranties on any market where the product is sold, as well as information on how to purchase an extended warranty, for example, directly from the brand owner's webshops or through a retailer.

If product components have different warranty periods, or if different warranty periods are offered in different regions, the worst-case scenario (least number of years) must be used in the statement.

Link to a public commitment on warranty covering the certified product

The link must be functioning during the validity of the certificate. If the URL is changed, then it must first be approved by TCO certified and the new URL added to the certificate.

Minimum included product warranty

This is the minimum number of years (at least 1 year) of product warranty that is included for free on all markets where the product is sold.

Minimum purchasable extended warranty

This is the minimum optional extension of the product warranty, offered for purchase with the product on all markets.

Minimum total available warranty

This is the worst-case combination of "included product warranty" and "purchasable extended warranty" on any market where the product is sold.

Maximum warranty cost per year (in % of product cost)

This is the maximum annual cost for the purchasable extended warranty must not exceed 15% of the MSRP cost of the product.

6.2 Replaceable components

Background

Extending the lifetime of IT products is the most effective way to reduce their environmental impact. Components that often break or become outdated may limit the total lifespan of the product and must be replaceable. By providing the user with clear instructions on how to replace these critical components, IT-products can live longer.

Definitions

CPU: Central processing unit.

GPU: Graphics processing unit.

RAM: Random access memory.

Storage: Any computing hardware that is used for storing, porting, and extracting data files and objects, including temporary and permanent storage of information (SSD, HDD, RAM).

Display assembly: Main display panel.

All batteries: Defined as all batteries with one or more cells that are installed in the product.

System board: Also referred to as the motherboard.

Keyboard: Built-in keyboard.

External/Internal PSU: The power supply unit used to convert AC to low voltage DC power for the internal components of the product.

Critical, replaceable components: Components that are crucial for the functionality and have a high risk of failing during normal use. Components that are defined as critical, replaceable components (per product category) are listed in the clarifications section of this criterion.

Applicability

All product categories.

References

6.1, 6.2.

6.2.1 Mandate

- The brand owner must provide a service manual describing how to replace at least all critical replaceable components. The service manual must be available for anyone to read, free of charge.

Submit the following to an approved verifier:

- A completed and signed brand owner product form (chapter 11.4)
- A link to the service manual on the brand owner website or a pdf of the material that will be published there during the validity of the certificate

The following is submitted to TCO Development:

- A copy of the verification report(s) from a verifier approved by TCO Development, including the link and instructions on how to locate the service manual.

6.2.2 Clarification

Replaceable parts management

- The brand owner must provide a service manual including step-by-step instructions and component descriptions for the disassembly and assembly.
 - External PSU, charger, and AC Adapters are exempted from the disassembly instructions.
 - If instructions on how to replace all critical replaceable components (listed below) are included in the user manual, no additional service manual is needed to comply with the mandate 6.2.1.
- Board diagrams must be available for professional repairers free of charge.
- A critical, replaceable component must be possible to replace with an equivalent component. However, the replacement component does not have to be identical to the original component.
- Instructions on how to replace the critical components must be available online during the validity of the certificate.
- If a critical component is soldered, step-by-step instructions are not needed, however it must be stated that the component is soldered in the service- or user manual.
- For data center products (Servers, Storage products, Network equipment), if one or more critical replaceable component(s) are part of a controller canister or system board, the controller canister or system board must be treated as the critical component.
- Headband cushions which are molded do not need to be replaceable. Headband cushions designed to be snapped/mounted (for eg, with adhesive) shall be replaceable.

Critical replaceable components:

The critical replaceable components listed below must only be made available if they are included in the certified product.

Displays Connectivity cables Power cables External PSU System board/motherboard Display panel assembly	Tablets Battery Display Panel/display assembly External/internal PSU
All-in-one PCs CPU External/internal PSU Storage (SSD, HDD, ODD) System memory (RAM) System board/motherboard	Smartphones Battery Display Panel/display assembly Charger
Notebooks Battery Display Panel/display assembly Storage (SSD, HDD) System memory (RAM) External/internal PSU Keyboard System board/motherboard	Headsets Battery External/internal PSU Earloop Neckband Ear tips Ear cushions Microphone shield Headband
Desktops CPU GPU (PCIe) External/internal PSU Storage (SSD, HDD, ODD) System memory (RAM) System board/motherboard	Projectors The light source (except lasers) Filters External PSU

<p>Servers</p> <ul style="list-style-type: none"> System boards(s) Storage (i.e. SSD, HDD) CPU RAM Network device PSU Fan module(s) Connectivity cables Rack rails Cable management arms 	<p>Storage products</p> <ul style="list-style-type: none"> System board(s) Storage (i.e. SSD, HDD) Storage controller (i.e. RAID controllers) PSU Fan module(s) Batteries Connectivity cables Rack rails Cable management arms
<p>Network equipment</p> <ul style="list-style-type: none"> System board(s) Storage (i.e. SSD, HDD) PSU Fan module(s) Expansion module(s) I/O module(s) Connectivity cables Rack rails Cable management arms 	

Component table

6.3 Standardized connectors

Background

By using one standardized interface (USB Type-C) for charging and data transfer, fewer cables need to be manufactured, and the reuse of chargers and data cables can increase. USB Type-C is also designed to be more robust and future-proof than the existing USB Type-A and Type-B. Therefore, using USB Type-C helps prevent problems with failing ports.

Definitions

USB Type-C: A 24-pin USB connector system with a horizontally symmetrical "reversible" connector based on the "Universal Serial Bus Type-C Cable and Connector Specification".

Applicability

Notebooks, desktops, AIOs, smartphones, tablets

6.3.1 Mandate

The device must be equipped with at least one USB Type-C receptacle compatible with USB 3.1 Gen 1 or faster and that remains accessible and operational at all times.

Submit the following to an approved verifier:

- A completed and signed product form (chapter 11.3)
- A product manual including an exploded diagram of the device illustrating the types of connectors used.

The following is submitted to TCO Development:

- A copy of the verification report(s) from a verifier approved by TCO Development.
-

6.3.2 Clarification

Products with no connectors are exempted from this criterion.

6.4 Product durability

Background

The military standard MIL-STD-810H and the International Electrotechnical Commission IEC 60068-2 include a series of endurance tests such as low and extreme temperature and drop tests. Products that meet these requirements can last longer and be reused to a larger extent.

Definitions

MIL-STD-810H: Environmental Engineering Considerations and Laboratory Tests, a United States military standard for product durability.

IEC 60068-2: A collection of methods for environmental testing of electronic equipment and products.

Applicability

Notebooks, smartphones and tablets.

6.4.1 Mandate

The product must be tested according to the MIL-STD-810H or IEC 60068-2 test procedure with the modified storage / operational temperature interval and duration as well as the drop test height according to the table below. The results will be reported on the certificate.

Test	Test conditions	Required level
Drop test	Drop height	≥ 45 cm
High temperature	Storage temperature for ≥ 48 h	≥ 60 °C
	Operational temperature for ≥ 4 h	≥ 40 °C
Low temperature	Storage temperature for ≥ 48 h	≤ -30 °C
	Operational temperature for ≥ 4 h	≤ -20 °C

Submit the following to an approved verifier:

- A copy of the test report(s) from a laboratory accredited according to ISO 17025.

The following is submitted to TCO Development:

- A copy of the verification report from a verifier approved by TCO Development.

The following is submitted to TCO Development and may be published:

- The drop test, high- and low temperature test results must be reported in TCO Certified Portal.

6.4.2 Clarification

Assessment and verification

The applicant must provide test reports showing that the model has been tested and has met the functional performance requirements for durability. Testing must be carried out by a test facility accredited according to ISO 17025 and the test report must be verified by a verifier approved by TCO Development.

Products which have already been tested to the same or a stricter specification, will be accepted without the need to retest. The following methods are accepted.

For MIL-STD-810H the following methods apply

- Drop test: Method 516.8 - Shock (procedure IV)
- High temperature: Method 501.7 - Basic Hot (A2)
- Low temperature: Method 502.7 - Basic Cold (C1)

Unless it can be proved that the plastics or rubber material in the product is unaffected by the applied test-temperature (as mentioned in paragraph 5.19 Total High Temperature Exposure Duration and Method 502.6 - 2.3.2 Exposure Duration), the duration of the high temperature test (method 501.7 Basic Hot (A2)) and the low temperature test (Method 502.7 Basic Cold (C1)) must be at least 48h in storage and 4h in operation. If a stricter testing is applied, such as Cold (C2) or Severe Cold (C3) then the duration must be at least 4h in storage and 4h in operation.

For IEC 60068-2 the following methods apply

- Drop test: 60068-2-31:Ec
- High temperature: IEC 60068-2-2:B
- Low temperature: 60068-2-1:Ab/e.

Test evaluation

The product under test shall first be baseline tested for performance at 20 °C with a fully charged battery. All operation tests shall be started with a fully charged battery in the system. During the low temperature operational test, the product may be switched on at ≤ 0 °C.

After exposure to any of the three specified stress tests, the product should be able to:

1. Boot up and operate normally
 - Boot or resume should not exceed 50% greater time increase as a result of the test.
 - No noticeable operational faults when using standard software applications (Excel, Word etc).
 - No major damage to the product that does not allow for standard usage, e.g.,- opening/closing of the notebook display, usage of any critical buttons, non-functional display.
2. Not create hazards to end user
 - No case or display cracking or other sharp points created from failures that could injure a user.
 - No electrical component failures or access that could result in a user safety issue.

6.5 Battery longevity

Background

Short life cycles for IT products is a global problem connected to product design, user habits and end of life solutions. One important reason why portable IT products are discarded prematurely is that the battery loses its capacity over time and becomes too degraded to provide enough power for the product. The product experience could many times be improved by replacing the battery instead of buying a new product.

Definitions

Main battery: Unit that incorporates one or more cells and which is ready for use. It incorporates adequate housing and a terminal arrangement and may have electronic control devices (IEC 61960).

State of Health (SoH): Current full charge capacity (in mAh), expressed as a percentage of the design capacity (rated capacity).

Rated capacity: The specified capacity by the manufacturer.

Applicability

Battery-operated products

References

6.3-6.6

6.5.1 Mandate

- The main battery must be able to withstand a minimum of 300 charging cycles with at least 90% of the rated capacity according to IEC 61960-3:2017 or newer.

Submit the following to an approved verifier:

- A copy of the test report(s) from a laboratory accredited according to ISO 17025.
- A completed and signed product form (chapter 11.3).

The following is submitted to TCO Development:

- The battery model name, technology, rated capacity, rated voltage, rated power and the tested number of charging cycles for all main batteries must be reported in TCO Certified Portal.
- A copy of a verification report from a verifier approved by TCO Development.

The following is submitted to TCO Development and may be published:

- The tested number of charging cycles with at least 90% of the rated capacity remaining.

6.6 Battery replaceability

Background

Batteries are consumables, often with a shorter life than the product they are installed in. To extend the total lifespan of the product, main batteries must be replaceable, so that products can be repaired and reused. Another concern that makes replaceability important is that the explosive cells of Lithium-ion batteries may pose a fire risk when shredded in the recycling process, causing a hazardous situation for recyclers.

Definitions

Main battery: Unit that incorporates one or more cells and which is ready for use. It incorporates adequate housing and a terminal arrangement and may have electronic control devices (IEC 61960).

Reuse: Reuse is the second step in the waste hierarchy: waste prevention, reuse, recycling, recovery of energy and safe disposal.

Recycle: The purpose of recycling is to recover materials from waste, for use in the production of new products by upcycling or downcycling. Recycled materials can also be used as a component in new raw materials.

Earbuds: Earbuds rest on the concha – the opening outside the ear canal

Earphones: Earphones – also known as in-ear headphones – are inserted in the ear canal

Tools are defined under the criterion replaceable components

Applicability

Battery-operated products.

6.6.1 Mandate

- The battery must be replaceable by the end-user with the use of commercially available tools or tools provided free of charge with the product. No proprietary tools, thermal energy, or solvents must be necessary to replace the battery.
- The battery must be available for anyone to purchase
- The instructions on how to replace the battery must be available for anyone to read, free of charge online throughout the whole lifetime of the certificate.

Submit the following to an approved verifier:

- A link to instructions on the brand owner website or a pdf of the material that will be published there during the validity of the certificate
- A completed and signed product form (chapter 11.3)

The following is submitted to TCO Development:

- A copy of the verification report(s) from a verifier approved by TCO Development.

The following is submitted to TCO Development and may be published:

- The toolless battery replacement evaluation must be submitted to TCO Certified Portal.

6.6.2 Clarifications

Headsets products defined as earbuds and earphones are exempted from the battery replaceability mandate. "Replacing the battery" means to disassemble the product (if needed), exchange the battery with a new one and assemble the product to its original state.

Toolless battery replacement (Yes/No)

- **Yes:** The main battery is possible to replace by the user without tools.
- **No:** The main battery is not possible to replace by the user without tools.

Verification: The verifier must check if the main battery is possible to replace by the user without tools.

Draft 2

6.7 Battery information and protection

Background

While extending the life of IT products is key to lowering its environmental impact, mobile IT products are often replaced because the battery has lost its capacity to deliver enough power which limits the functionality of the product. Each charging cycle will degenerate the battery and reduce the battery's capacity to hold a charge. To slow down the degradation of the battery, battery protection software that lowers the maximum battery charge level to at least 80% can extend the total lifetime of the battery. It is also important that the user understands how the performance of the product changes as the battery degrades. When the user has access to this information they are better equipped to make decisions on when it is time to replace the battery instead of changing the whole product.

Definitions

Charge cycle: One charge cycle is completed when the battery is charged from 0% to 100% and then discharged back down to 0%. This could be performed by partially charging-discharging the battery multiple times on different State of Charge (SoC) levels as long as the total amount of charge-discharge percentage is approximately equal to the nominal capacity.

State of Health (SoH): Current full charge capacity (in mAh), expressed as a percentage of the design capacity (rated capacity).

State of Charge (SoC): The remaining battery capacity expressed as a percentage of full-charge capacity (SBS-IF, 1998).

Applicability

Notebooks, smartphones, tablets.

6.7.1 Mandate

1. The brand owner must provide battery protection software that can lower the maximum battery charge level (SoC) to 80% or less. It must be pre-installed on the product.
2. The brand owner must provide software pre-installed that can determine and monitor the following, and display the data for the user:
 - State of Health
 - State of Charge
 - The number of full charge cycles that the battery has gone through.

Submit the following to an approved verifier:

- A completed and signed product form (chapter 11.3).
- Documentation showcasing how point 1 and 2 in the mandate is fulfilled.

The following is submitted to TCO Development:

A copy of the verification report(s) from a verifier approved by TCO Development.

6.7.2 Clarification

The brand owner must specify the name and version of the software(s).
Chrome OS products are excluded from point 1 in this mandate.

In part 2 of the mandate, The “State of Health” and “The number of full charge cycles that the battery has gone through” are not applicable if the battery is replaceable by the user without tools.

Draft 2

6.8 Secure data removal

Background

By reusing IT products, their usable life can be extended which is an effective way of reducing their environmental impact. However, fear of confidential data leakage often prevents companies and individuals from making their products available on the second-hand market. By providing software that wipes the storage of the device, the owner can more safely recirculate their product.

Definitions

Brand owner: The company or organization owning or controlling the brand name.

Brand name: The name or sign, including but not limited to a trademark or company name, used to identify, amongst users and customers, the manufacturer or seller of a product.

Media sanitization: refers to a process that renders access to target data on the media infeasible for a given level of effort.

Applicability

Notebooks, network equipment, desktops, all-in-one PCs, servers, data storage products, smartphones and tablets.

Reference

6.7.

6.8.1 Mandate

The brand owner must provide a media sanitization solution, either by:

1. Pre-installing it on/in the product before it is shipped.
2. Providing the software for download on their webpage, free of charge.
3. Providing a direct link on their own webpage to an external webpage where the software is available for download, free of charge.
4. Providing a remote secure data removal service upon request, free of charge.
5. Providing an on-site secure data removal service upon request, free of charge.

The selected media sanitization solution above must conform with the method of "Clear" in IEEE P2883. Users must be able to use it at least once, free of charge.

OR

6. Pre-installed data encryption technologies that allow for erasure or removal of the encryption keys.

Instructions on how to use this functionality, the techniques used and the secure data deletion standard(s) it supports must be provided in the user manual and/or by a web link to the manufacturer's webpage.

The following is submitted to TCO Development:

- A completed and signed product form (chapter 11.3).

Submit the following together with the application to TCO Development:

- A copy of the verification report from a verifier approved by TCO Development.

6.8.2 Clarification

Pre-installed data encryption technologies must have a security stronger or equal to: AES encryption algorithm in cipher block chaining (CBC) or XTS mode with a 128-bit or 256-bit key.

Draft 2

6.9 Standardized external power supply compatibility

Background

Today, cables and chargers are manufactured to many different standards, which makes them difficult to reuse. By using one standardized interface (USB Type-C) for wired charging and one standard (Qi) for wireless charging, fewer cables and chargers need to be manufactured and the re-use of chargers and data cables can increase.

Definitions

USB Type-C: A 24-pin USB connector system with a horizontally symmetrical "reversible" connector based on the "Universal Serial Bus Type-C Cable and Connector Specification".

EPS: External Power Supply

Applicability

All products with rechargeable batteries and external power supplies ≤ 240 W.

6.9.1 Mandate

- A. The product must carry a USB Type-C standardized receptacle (port) for USB Power Delivery according to the standard EN/IEC 63002:2021 - Identification and communication interoperability method for external power supplies used with portable computing devices or newer.

OR

- B. The product must have a built-in wireless charging capability that complies with Qi Wireless Power Transfer System, Power Class 0 Specification version 1.2.4, or future revisions.

Submit the following to an approved verifier:

- A completed and signed product form (chapter 11.3).

The following is submitted to TCO Development:

- A copy of the verification report(s) from a verifier approved by TCO Development.

6.9.2 Clarification

Interoperability guidelines for external power supplies are defined according to the IEC 63002:2021 or newer (Identification and communication interoperability method for external power supplies used with portable computing devices.)

For products delivered with a charging case, the case must fulfill the criterion.

6.10 Repairability index

Background

In order to make IT products more sustainable and avoid early disposal and E-waste, it is important that they are designed for easy repair, with easily accessible parts, clear guidelines, and a supply of replacement components. A repairability index provides stakeholders with a comprehensive assessment of a product's repairability. It is our ambition to align with global standards and regulations when possible, such as the EU Lot 3 mandate on repairability. Therefore this mandate may be revised when new EU regulations covering this come into force in the future.

Applicability

Smartphones, Tablets, Notebooks

6.10.1 Mandate

The below aspects must be evaluated and calculated into a repairability index.

- Disassembly depth for all listed parts
- Fasteners (type)
- Tools (type)
- Spare Parts information
- Repair Information
- Spare Parts (duration)

Submit the following to an approved verifier:

- A completed and signed product form (chapter 11.3)
- Sufficient technical documentation to judge all aspects of the mandate

The following is submitted to TCO Development:

- Filled out Repairability score excel from a verifier approved by TCO Development.

The following is submitted to TCO Development and may be published:

- The calculated repairability index submitted to TCO Certified Portal

6.10.2 Clarifications

The repairability index must be calculated according to EU COMMISSION DELEGATED REGULATION (EU) 2023/1669 of 16 June 2023 or a more recent version. Notebooks are treated as tablets except for the critical components which are listed in this mandate. TCO Development provides a downloadable excel on their website to simplify this calculation.

The Repairability Index is an aggregated and normalized score, as a calculated value derived from the following six scoring parameters:

- Disassembly Depth.
- Fasteners (type).
- Tools (type).

- Spare Parts.
- Software Updates (duration).
- Repair Information.

The “Disassembly Depth”, “Fasteners (type)” and “Tools (type)” scores are based on the aggregation of the following priority parts:

Mobile phones and Tablets.

- Battery.
- Display assembly.
- Back cover or back cover assembly.
- Front-facing camera assembly.
- Rear-facing camera assembly.
- External charging port.
- Mechanical button.
- Main microphone(s).
- Speaker.
- Hinge assembly or the mechanical display folding mechanism.

Notebooks

- Battery (if multiple, consider deepest)
- Display assembly (if multiple, consider deepest)
- Keyboard
- Storage (SSD,HDD) (if multiple, consider deepest)
- System memory (RAM) (if multiple, consider deepest)
- Ports (Vga, Hdmi, USB,)
- Back cover or its assembly
- Systemboard/motherboard
- Fans

If any of the priority parts listed above is present in a product more than once, only the one that delivers the lowest score shall be considered in the calculation of the “Disassembly Depth”, “Fasteners (type)” and “Tools (type)” scores. If a priority part is not present in the product, the highest point level for each score shall be considered for this part.

Disassembly Depth (DD) assessment at part level

The Disassembly Depth score for each priority part shall be calculated based on the number of steps required to remove a part from a product, without damaging the product. The counting of the steps for each part starts from the product fully assembled, with the charger disconnected and any SIM card installed. Points ranging from 1 to 5 are assigned as follows:

- $DD \leq 2$ steps = 5 pt.
- 5 steps $\geq DD > 2$ steps = 4 pt.
- 10 steps $\geq DD > 5$ steps = 3 pt.
- 15 steps $\geq DD > 10$ steps = 2 pt.
- $DD > 15$ steps = 1 pt.

Definition of step: ‘step’ means an operation that finishes with the removal of a part (or bundle) or with a change of tool; any placement of a part away from its initial location, even if that entails partial disconnection or unplugging, shall also be considered as removal.

For the calculation of disassembly steps, the following rules shall apply:

- The disassembly depth count is completed when the target part is separated and individually accessible.
- Where multiple tools need to be used simultaneously, the use of each tool counts as a separate step.
- Operations related to cleaning, removing traces or heating are counted as steps.
- The disassembly depth shall be calculated on the basis of the repair and maintenance information, and of the description of the disassembly steps for each priority part given in the technical documentation;
- where remote notification or authorization of serial numbers or parts pairing is necessary for the full functionality of the spare part with the device, each of these actions is counted as five additional disassembly steps.
- software preparation steps do not count as steps for disassembly. (for example, shut down the battery in bios before disassembly = 0 steps added).

Fasteners (type) (F) assessment at part level:

The “Fasteners (type)” scores for each priority part are assigned according to the level of removability and reusability of the fasteners used in the device assembly. Points ranging from 1 to 5 are assigned as follows:

- Reusable Fasteners = 5 pt.
- Resupplied Fasteners = 3pt.
- Removable Fasteners =1 pt.
- Non removable fasteners = 0pt

The assessment of the type of fasteners is based on the disassembly process to remove the specific priority part, starting from the previous priority part in disassembly sequence already removed. In case different types of fasteners are encountered in the disassembly of a priority part, the worst score shall be considered. The Fi scores shall be calculated on the basis of the repair and maintenance information, and of the description of the fasteners for each priority part given in the technical documentation. The “Tools (type)” (ST) score shall be calculated as follows:

Tools (type) (T) assessment at part level

The “Tools (type)” scores for each priority part i are assigned according to the complexity and availability of the tools needed for its replacement. Points ranging from 1 to 5 are assigned as follows:

- No tools = 5 pt;
- Basic tools = 4pt.
- A set of tools that is supplied (or offered to be supplied at no additional cost) with the spare part = 3 pt.

- A set of tools that is supplied (or offered to be supplied at no additional cost) with the product = 2 pt.
- Commercially available tools =1pt.

Tools Definitions:

basic tools - means a screwdriver for slotted heads, a screwdriver for cross recess screws, a screwdriver for hexalobular recess heads, a hexagon socket key, a combination wrench, combination pliers, combination pliers for wire stripping and terminal crimping, half round nose pliers, diagonal cutters, multigrip pliers, locking pliers, a prying lever, tweezers, magnifying glass, a spudger and a pick;

commercially available tool - means a tool that is available for purchase by the general public and is neither basic tools nor a proprietary tool;

The assessment of the type of tools is based on the disassembly process to remove the specific priority part, starting from the previous priority part in disassembly sequence already removed. Where different types of tools are needed for the disassembly of a priority part, the lowest score shall be considered. The Ti scores shall be calculated on the basis of the repair and maintenance information, and of the description of the tools for each priority part given in the technical documentation.

Spare parts score for smartphones and tablets shall be:

The "Spare Parts" score shall be calculated at product level as follows:

- Spare parts for all priority parts are available to end users and professional repairers = 5 pt;
- Spare parts for display assembly, battery, back cover (or back cover assembly) and cameras are available to end users and professional repairers; spare parts for all other parts are available to professional repairers = 4 pt;
- Spare parts for display assembly, battery and back cover (or back cover assembly) are available to end users and professional repairers; spare parts for all other parts are available to professional repairers = 3 pt;
- Spare parts for display assembly and battery are available to end users and professional repairers; spare parts for all other parts are available to professional repairers = 2 pt;
- Spare parts for display assembly are available to end users and professional repairers; spare parts for all other parts are available to professional repairers = 1 pt;
- Spare parts for the hinge assembly, mechanical display folding mechanism are to be available only in case of foldable smartphones.

Spare parts score for Notebooks shall be:

- Battery and Display assembly to end users All other to professionals = 1pt
- Battery, Display assembly & Keyboard to end users; All other to professionals = 2pt
- Battery, Display assembly & Keyboard,Storage & Ram to end users; All other to professionals = 3pt
- Battery, Display assembly & Keyboard,Storage, Ram, Ports & Back cover to end users; All other to professionals = 4pt

- All parts = 5pt

Software updates (smartphones and tablets).

The 'Software Updates (duration) score shall be calculated at product level as follows:

- Minimum guaranteed availability of security updates, corrective updates and functionality updates to the operating system for at least 7 years = 5 pt.
- Minimum guaranteed availability of security updates, corrective updates and functionality updates to the operating system for 6 years = 3 pt.
- Minimum guaranteed availability of security updates, corrective updates and functionality updates to the operating system for 5 years = 1 pt.

The above durations refer to years from the date of end of placement on the market of the product model.

Spare parts (duration)

The "Spare parts (duration)" score shall be calculated through the different spare parts levels bundled as follows:

Level 1 (most critical components): Battery, Display assembly

Level 2: Keyboard, Storage, System memory (RAM)

Level 3 (least critical components): Ports, Back cover or its assembly, Systemboard/motherboard, Fans

- Level 1 and Level 2 = 10 yrs; Level 3 = 9 years 5pt
- Level 1 and Level 2 = 9 yrs; Level 3 = 8 years 4pt
- Level 1 and Level 2 = 8 years; Level 3 = 7 years 3pt
- All parts available for 7 years. 2pt
- Level 1, Keyboard, storage, ports/connect 7 years 1pt

The above durations refer to years from the date of end of placement on the market of the product model.

Repair Information

The Repair Information score shall be calculated at product level as follows:

- Public availability of repair and maintenance information,
 - except electronic board diagrams, at no cost for end users and availability of repair and maintenance information,
 - including electronic board diagrams, at no cost for professional repairers
 = 5 pt.
- Availability of repair and maintenance information at no cost for professional repairers = 3 pt.
- Availability of repair and maintenance information with a reasonable and proportionate fee for professional repairers = 1 pt.
- A fee shall be considered reasonable if it does not discourage access by failing to take into account the extent to which the professional repairer uses the information.

Definition of repair and maintenance information according to COMMISSION REGULATION (EU) 2023/1670 of 16 June 2023:

The repair and maintenance information shall contain the level of detail needed to be able to replace all priority parts for smartphones, tablets and notebooks and shall at least include:

- the unequivocal product identification
- a disassembly map or exploded view;
- wiring and connection diagrams, as required for failure analysis;
- electronic board diagrams;
- a list of necessary repair and test equipment;
- technical manual of instructions for repair, including marking of the individual steps;
- diagnostic fault and error information (including manufacturer-specific codes, where applicable);
- component and diagnosis information (such as minimum and maximum theoretical values for measurements);
- instructions for software and firmware (including reset software);
- information on how to access data records of reported failure incidents stored on the device, where applicable, with the exception of personal identifiable information such as related to user behavior and location information;

The repairability index excel can be found at

<https://tcocertified.com/industry/certification-documents/>

6.11 Security and functionality software updates

Background

Devices may become obsolete or vulnerable due to infrequent software updates, putting user data at risk and curtailing device longevity. Therefore TCO Certified intends to address the following challenges:

- Consumer Protection: Consistent security updates minimize risks from cyber threats and unauthorized data access.
- Device Longevity: By ensuring functionality updates, devices remain relevant longer, delivering better value to users and reducing electronic waste.
- Holding Manufacturers Accountable: This enforces a set support duration, nudging manufacturers towards more sustainable designs and post-sale maintenance.

Definitions

- Security update: An operating system update, including security patches, if relevant for a given device, whose main purpose is to provide enhanced security for the device.
- Corrective update: An operating system update, including corrective patches, whose purpose is to provide corrections to bugs, or malfunctions in the operating system.
- Functionality update: An operating system update whose main purpose is to implement new functionalities.
- "The date of end of placement on the market" is defined as "the last manufacturing date" in this criterion.

Applicability

All product categories.

6.11.1 Mandate

- The brand owner must publicly guarantee the availability of free-of-charge security updates, corrective updates and functionality updates to the operating system for at least 5 years after the end of placement on the market.

Submit the following to an approved verifier:

- A completed and signed brand owner product form (chapter 11.4).
- A link to a public statement where the brand guarantees the availability of these updates.
- The last year, the brand owner publicly committed to delivering such updates.

The following is submitted to TCO Development:

- A copy of the verification report(s) from a verifier approved by TCO Development.

The following is submitted to TCO Development and may be published:

- A link to a public statement where the brand guarantees the availability of these updates.
- The last year, the brand owner publicly committed to delivering such updates.

6.11.2 Clarification

The manufacturing date is possible to verify on a product level in a spot check program. The last manufacturing date is considered representative of “the date of end of placement on the market.” Therefore, “the date of end of placement on the market” is defined as “the last manufacturing date” in this criterion.

Verification guideline

The brand owner must provide a link to a public statement where they guarantee the availability of security updates, corrective updates and functionality updates to the operating system for at least 5 years after the end of production of the certified product as well as information on how these updates will be provided. The link must be functioning during the validity of the certificate.

The software updates must cover the operating system delivered with the product or a newer version of the same operating system that must then be supported by the product without any additional cost for the user.

7 Reduction of hazardous substances

- Hazardous substances used in IT products risk human health and the natural environment.
- Legislation is lagging and focuses on banning substances, but the substitutions can be just as hazardous or even worse.
- TCO Certified drives transparency and knowledge-sharing, developing pathways to safer alternatives.

Hazardous substances – a risk to human health and the environment

No one knows how many chemicals are in use today. What we do know is that very few of these substances have been studied for their impact on humans and the environment. Examples of potentially hazardous substances are plasticizers, flame retardants and stabilizers, often used in components, cables and other plastic parts. These substances risk leaking out in the natural environment, both in connection with manufacturing, and when products and their packaging are incinerated, placed in landfill or recycled in an improper way.

Keeping hazardous substances out of products is also important from a circular perspective. Contaminated materials cannot be responsibly recycled and reused in new products and risk therefore being incinerated or discarded, adding to the enormous e-waste problem.

Our approach: guiding the IT industry to safer alternatives

For a long time, TCO Certified has restricted the use of harmful substances with criteria that go beyond RoHS. However, simply banning substances isn't enough. A banned substance may be replaced with another that is equally harmful or potentially even worse. Therefore, we need better information about substances before they are being used. With TCO Certified, a chemical is considered a high risk until it is proven to be otherwise. GreenScreen® for Safer Chemicals is used to identify a pathway to safer alternatives.

Criteria in chapter 7 focus on:

- Reducing or eliminating the use of hazardous substances in IT products and their packaging beyond RoHS.
- Requiring that all flame retardants, plasticizers and stabilizers are assessed by an independent toxicologist and benchmarked as a safer alternative before being used in certified products. The same principle applies also to process chemicals, covered in chapter 2.
- Increasing transparency and making safer alternatives the mainstream choice by collecting all approved substances on the public and dynamic TCO Certified Accepted Substance List.

7.1 Heavy metals

Background

Electronic devices contain hazardous substances like heavy metals and brominated flame retardants. The effects of cadmium, mercury, lead and hexavalent chromium are well documented as substances hazardous both to human health and the environment. They may cause problems, both in the manufacturing phase where workers or the environment can be exposed, and at the material recovery, where uncontrolled recycling can cause the release of toxins such as dioxins and furans.

This criterion is harmonized with EU RoHS Directive (2011/65/EU), except that in TCO Certified, mercury is not allowed in lamps. As TCO Certified is a global certification, this also affects products sold outside the EU.

Applicability

All product categories.

References

7.1, 7.2.

7.1.1 Mandate

The product must not contain cadmium, mercury, lead and hexavalent chromium

Exemptions are according to EU Directive 2011/65/EU (RoHS) and the documents supporting the directive, except that mercury in lamps is not permitted.

The maximum concentration values tolerated by weight in homogeneous materials are 0.01% for cadmium, 0.1% for mercury, 0.1% for lead and 0.1% for hexavalent chromium according to EU RoHS Directive (2011/65/EU annex II) and the documents supporting the directive.

The limit value for batteries is 0.0005 % for mercury, 0.002 % for cadmium and 0.004 % lead per listed part, according to Regulation (EU) 2023/1542.

Submit the following to an approved verifier:

- A completed and signed product form (chapter 11.3).

The following is submitted to TCO Development:

- A copy of a verification report from a verifier approved by TCO Development.
-

7.2 Halogens

Background

Halogenated substances are often persistent and can bio-accumulate in living organisms. They are problematic from both a human health and environmental perspective throughout the product life cycle and should be phased out. Workers may be exposed during manufacturing. Substances risk leaking out into the natural environment at end of life. PVC is by far the most common halogen-containing plastic.

Definitions

An electronic component is considered an individual part or combination of parts that, when together, perform a design function(s) and are typically directly attached to a printed circuit board. Internal and external power supplies are not included in the definition.

Product housing protects internal components and safeguards the user against injury from these electrical components. Product safety standards define these safeguards as different types of protective enclosures. These enclosures are added to safeguard against electrical shock, high temperatures, fire and mechanical (moving parts such as the fan), and radiation (such as any internal laser), whilst also protecting internal parts.

Printed circuit board (PCB) or printed wiring board (PWB) laminate is a printed board that provides point-to-point connections.

Power board or power PCB regulates the power leading to the device, converting alternating current to direct current

Polybrominated biphenyls (PBB) and polybrominated diphenyl ethers (PBDE) are restricted in the EU RoHS Directive (2011/65/EU) due to the hazardous properties of these substances.

Hexabromocyclododecane (HBCDD) has been identified as a substance of very high concern in accordance with EU REACH criteria due to PBT (persistent, bio-accumulative, toxic) properties.

External cables delivered with the product: Cables that provide power to the product and cables that connect the product to an external peripheral (USB-USB, HDMI-HDMI, HDMI-DP, VGA-VGA, etc).

Applicability

All product categories.

References

7.2, 7.3.

7.2.1 Mandate

1. Product housing parts above 0.5 grams, printed circuit board (PCB) laminates and external cables delivered with the certified product must not contain intentionally added (additive or reactive) halogenated flame retardant, plasticizer or vinyl polymer stabilizer substances.

Exempted are all other parts, such as electronic components and PCB laminates sealed inside electronic components.

2. The product must not contain PBB, PBDE and HBCDD. No parts of the product are exempted.
3. The largest PCB by area in the power supply unit (internal/external) must be tested for bromine and chlorine (see clarification below).

Maximum concentration values tolerated for a non-accepted substance (including decaBDE) is 0.1% by weight of the material in homogeneous materials.

Fluoroorganic additives, used to modify the dripping behavior of plastics in fire conditions or to improve the processing behavior, are exempted provided that they do not exceed 0.5% by weight of the material in homogeneous materials.

Submit the following to an approved verifier:

- A completed and signed product form (chapter 11.3).
- A copy of the test report(s) from any laboratory accredited according to ISO 17025

The following is submitted to TCO Development:

- A copy of the test report(s) from any laboratory accredited according to ISO 17025 and a copy of the verification report(s) from a verifier approved by TCO Development.

7.2.2 Clarification

1. Applies to product housing parts above 0.5 grams. This includes the product stand and the housing of the external power supply. The internal or external power supply socket or inlet is included in the definition of product housing.

PCB laminates completely sealed within an electronic component are exempted.

External cables delivered with the product are considered cables provided to supply power to the product and connect the product to an external peripheral (USB-USB, HDMI-HDMI, HDMI-DP, VGA-VGA, etc).

See mandate for non-halogenated substances for the requirements on safer substitution.

2. Applies to the whole product, including components, parts and raw materials in all assemblies and sub-assemblies, such as batteries, paint, surface treatment, plastics, electronic components and printed wiring boards.

3. Applies to the testing for bromine and chlorine where the following is required:

The largest PCB by area in the power supply unit must be tested for bromine and chlorine. The PCB must be tested in its final state with PCB laminates included but does not need to be tested with electrical components attached. Testing must be conducted through either IEC 62321-3-1:2013, 62321-3-2:2020 or EN14582 by an ISO 17025 accredited laboratory. If the same PCB is used in multiple products, a test report may be used for multiple products if traceability between the tested sample and the product is verified.

- If indications of bromine or chlorine $>0.1\%$ are discovered, the applicant must proceed with additional testing to prove compliance with this criterion.
- If the concentration of a detected substance is $<0.1\%$, then no additional testing is needed.

Draft 2

7.3 Non-halogenated substances

Background

Hazardous non-halogenated substances are problematic in the manufacturing and material recovery phases where workers and the environment can be exposed, leading to human health and environmental risks. This criterion aims to increase the knowledge of which non-halogenated substances are used in certified products, how hazardous they are to human health and the environment, and to drive a shift toward less hazardous alternatives.

This mandate uses the chemical hazard assessment and decision logic framework GreenScreen® for Safer Chemicals, developed by the non-profit organization Clean Production Action (CPA), and the ChemFORWARD hazard banding system based on the Cradle to Cradle Material Health Assessment Methodology.

Both methods align with international standards and regulations that assess chemicals' human health and environmental risks. These include the Regulation on the classification, labelling and packaging of substances and mixtures (CLP), the Globally Harmonized System of Classification and Labelling of Chemicals (GHS), OECD testing protocols, European REACH Regulation that includes RoHs, POPs, SVHCs and the U.S. EPA's Design for Environment (DfE) Alternatives Assessment.

Definitions

Licensed GreenScreen Profilers and ChemFORWARD qualified assessors: Independent toxicology firms licensed/qualified by CPA/ChemFORWARD to provide assessment services for a fee to clients.

TCO Certified Accepted Substance List: Public list of independently assessed safer available alternatives considering toxicity and functionality.

An electronic component is considered an individual part or combination of parts that when together, perform a design function(s) and are typically directly attached to a printed circuit board. Internal and external power supplies are not included in the definition.

Product housing protects internal components and safeguards the user against injury from these electrical components. Product safety standards define these safeguards as different types of protective enclosures. These enclosures are added to safeguard against electrical shock, high temperatures, fire and mechanical (moving parts such as the fan), and radiation (such as any internal laser), whilst also protecting internal parts.

External cables delivered with the product: Cables that provide power to the product and cables that connect the product to an external peripheral (USB-USB, HDMI-HDMI, HDMI-DP, VGA-VGA, etc).

Applicability

All product categories.

References

7.4, 7.5, 7.6.

7.3.1 Mandate

Product housing parts above 0.5 grams, printed circuit board (PCB) laminates and external cables delivered with the certified product must only contain intentionally added (additive or reactive) non-halogenated flame retardants and vinyl polymer stabilizers that appear on TCO Certified Accepted Substance List.

All substances of a flame retardant and stabilizer mixture must be accounted for.

Non-accepted substances must not exceed concentration levels of 0.1% by weight of the flame retardant and stabilizer.

Exempted are all other parts, such as electronic components and PCB laminates sealed inside electronic components.

Submit the following to an approved verifier:

- A completed and signed product form (chapter 11.3).

The following is submitted to TCO Development:

- A copy of a verification report from a verifier approved by TCO Development.
- A document copy or access to a database copy of the certified assessment report conducted and issued by a licensed GreenScreen Profiler.

7.3.2 Clarification

Applies to product housing parts above 0.5 grams. This includes the product stand and the housing of the external power supply. The internal or external power supply socket or inlet is included in the definition of product housing.

Only PCB laminates completely sealed within an electronic component are exempted.

External cables delivered with the product are considered cables provided to supply power to the product, and to connect the product to an external peripheral (USB-USB, HDMI-HDMI, HDMI-DP, VGA-VGA, etc).

TCO Certified Accepted Substance List

Non-halogenated flame retardants can be used in certified products once they receive an accepted GreenScreen benchmark or ChemFORWARD hazard band, and appear on the public TCO Certified Accepted Substance List. GreenScreen benchmarks 2, 3 or 4 assigned by a licensed GreenScreen profiler or hazard bands A, B or C assigned by a qualified ChemFORWARD assessor are accepted to appear on TCO Certified Accepted Substance List. A GreenScreen benchmark U may only be accepted when the “worst case scenario” for data gaps is considered a benchmark 2 or above. The list is dynamic, which allows new substances that have undergone a valid assessment to be added at any time. Accepted substances may be reassessed in light of new scientific findings.

TCO Development must have access to a copy of the GreenScreen and ChemFORWARD assessment reports before the substance can be added to TCO Certified Accepted Substance List.

Conformity procedure

- If all substances relevant to this mandate are confirmed by suppliers to be on TCO Certified Accepted Substance List, complete the product form 11.3 and submit it to an approved verifier. When the verifier considers all documentation compliant, they will issue an environmental verification to the applicant.
- If any substance relevant to this mandate does not yet appear on TCO Certified Accepted Substance List, then it must be added before approval can be given by a verifier. An extended time period to comply can be applied here (see “Applying for an extended period...” below).
- TCO Development will require manufacturers to disclose substance details used in randomly chosen products. To verify that the obligations according to this mandate are fulfilled CASNR disclosure and laboratory assessments of selected parts will be conducted to assess the completeness, quality and validity of a benchmark score.

Get a substance assessed and added to TCO Certified Accepted Substance List:

- First, determine if the substance is restricted or already has a valid assessment available.
 - a. Contact TCO Development to see if the substance is restricted.
 - b. Visit TCO Certified Potential Candidate List to see if a previous assessment has been completed and the profiler/assessor that completed it.
 - c. Visit the GreenScreen Assessment Registry or contact ChemFORWARD to see if a valid assessment is available.
- If the substance needs an assessment and depending on the chemical hazard assessment method chosen, a licensed GreenScreen profiler is found on the Clean Production Action website, and a qualified ChemFORWARD assessor is found on the ChemFORWARD website.
- Next, an extensive chemical hazard assessment will be assembled by the profiler/assessor from the available information (literature search, structural similarity comparison, expert judgment) covering human and environmental toxicology endpoints in accordance with GreenScreen or ChemFORWARD requirements
- The profiler/assessor sets the benchmark/hazard band per relevant substance. The assessment report is then valid for up to five years.
- Complete assessment reports must be submitted to TCO Development for final approval before a substance is added to TCO Certified Accepted Substance List.
- When the substance is added to the TCO Certified Accepted Substance List, it shows only the substance’s name, CASRN, type of additive, benchmark/hazard band, date of the assessment and profiler/assessor company name.
- Once a substance is added to the list and the environmental verifier identifies it, they will issue the environmental verification.

A substance being removed from TCO Certified Accepted Substance List:

- When the validity of a GreenScreen/ChemFORWARD assessment (5 years) has expired and not been updated, TCO Development will consider that the substance is no longer being used on certified products. In this case, the substance will be moved to TCO Certified Potential Candidate List.

- If a substance benchmark/hazard band has been degraded during the 5 year validity to a non-accepted benchmark/hazard band, it must be removed. The substance can continue to be used for up to 18 months from the degraded date. The removal date will be visible on TCO Certified Accepted Substance List.

Applying for an extended period to substitute or add a substance to TCO Certified Accepted Substance List

Applicants signing the mandate can seek an extended period to complete assessments or substitute restricted substances. Upon request for an extension, the applicant must complete a risk assessment questionnaire and submit it to TCO Development. The risk assessment requires the applicant to clarify why an extension is necessary, provide information on the chemical and its substitute, and include a timeline for completing the assessment and/or substitution. If an extension application is not granted, the applicant must ensure that all used flame retardant, plasticizer or stabilizer formulations only include substances on TCO Certified Accepted Substance List before an environmental verification can be issued for the product model. If an extension due date is exceeded without conformity, the verifier must contact TCO Development and a course of action will be decided after discussing the issue with the applicant.

7.4 Plasticizers

Background

Plasticizers are increasingly associated with negative environmental and human health impacts. RoHs is a restricted substances list that, beginning in 2019, restricts the use of four phthalates. TCO Development is committed to taking a much broader approach by identifying and restricting not only these four but all substances of high concern used in IT products. Our criteria are, therefore, designed to make sure that replacement substances are independently assessed as safer alternatives and that transparency increases. The full list of safer alternatives is available on tco-certified.com.

This mandate uses the chemical hazard assessment and decision logic framework GreenScreen® for Safer Chemicals, developed by the non-profit organization Clean Production Action (CPA), and the ChemFORWARD hazard banding system based on the Cradle to Cradle Material Health Assessment Methodology.

GreenScreen criteria align with international standards and regulations that assess chemicals on their human health and environmental hazards. These include the Regulation on the classification, labelling and packaging of substances and mixtures (CLP), the Globally Harmonized System of Classification and Labelling of Chemicals (GHS), OECD testing protocols, European REACH Regulation that includes RoHs, POPs, SVHCs and the U.S. EPA's Design for Environment (DfE) Alternatives Assessment.

Definitions

Plasticizer: An additive to a polymer (plastic), to increase its flexibility, transparency, durability, or longevity.

Phthalates: The most common type of plasticizer in PVC cables.

Licensed GreenScreen Profilers and ChemFORWARD qualified assessors: Independent toxicology firms licensed/qualified by CPA/ChemFORWARD to provide assessment services for a fee to clients.

TCO Certified Accepted Substance List: Public list of independently assessed safer available alternatives considering toxicity and functionality.

Product housing is the external enclosure or casing that protects the product's internal parts. This includes the product stand.

An electronic component is considered an individual part or combination of parts that when together, perform a design function(s) and are typically directly attached to a printed circuit board. Internal and external power supplies are not included in the definition.

External cables delivered with the product: Cables that provide power to the product and connect the product to an external peripheral (USB-USB, HDMI-HDMI, HDMI-DP, VGA-VGA, etc).

Applicability

All product categories.

References

7.4, 7.5, 7.6.

7.4.1 Mandate

- Product housing above 0.5 grams and cable and wire insulations must only contain intentionally added plasticizers that appear on TCO Certified Accepted Substance List. Exempted are connectors and wires sealed inside electronic components.
- The product must not contain Bis (2-ethylhexyl) phthalate (DEHP), Butyl benzyl phthalate (BBP), Dibutyl phthalate (DBP), and Diisobutyl phthalate (DIBP). No parts of the product are exempted.

All substances of a plasticizer mixture must be accounted for. Non-accepted ingredients must not exceed concentration levels of 0.1% by weight of the plasticizer.

Submit the following to an approved verifier:

- A completed and signed product form (chapter 11.3).

The following is submitted to TCO Development:

- A copy of a verification report from a verifier approved by TCO Development.
- A document copy or access to a database copy of the complete assessment report conducted and issued by an approved GreenScreen licensed profiler.

7.4.2 Clarification

The mandate applies to product housing above 0.5 grams. There is no weight threshold for cable and wire insulations. This includes internal and external power supply housing and external cables. Only wires completely sealed within an electronic component such as a HDD, SSD and ODD are exempted.

Examples of cables and wires include: Internal product cables that interconnect between components and are detachable at both ends, such as power and data/signal cables. Cables permanently attached to electronic components, such as fans and speakers. External cables delivered with the product are considered cables provided to supply power to the product and connect the product to an external peripheral (USB-USB, HDMI-HDMI, HDMI-DP, VGA-VGA, etc).

TCO Development must have access to a copy of the GreenScreen and ChemFORWARD assessment reports before the substance can be added to TCO Certified Accepted Substance List.

For more clarifications on adding substances to TCO Certified Accepted Substance List and accepted hazard assessment frameworks, see non-halogenated substances 7.3 clarifications.

7.5 Hazardous substances in product packaging

Background

The use of hazardous substances in packaging materials is problematic and should be minimized. It poses a risk to human health and the environment, not least because packaging materials have a short lifespan and generate large volumes of waste. Several hazardous substances are regulated in many countries, and the use of them should be phased out.

Applicability

All product categories.

References

7.7.

7.5.1 Mandate

The packaging material must not contain lead (Pb), cadmium (Cd), mercury (Hg) or hexavalent chromium (Cr6). Plastic packaging material must not contain organically bound halogens.

Submit the following to an approved verifier:

- A completed and signed product form (chapter 11.3).

The following is submitted to TCO Development:

- A copy of a verification report from a verifier approved by TCO Development.
-

7.5.2 Clarification

Limit values are according to Directive 94/62/EC on packaging and packaging waste.

8 Material Recovery

- More than 50 million metric tons of e-waste is generated every year and only a small amount is handled in a safe way.
- This leads to pollution, human health hazards and the loss of valuable finite resources.
- For a more sustainable life cycle, products and materials must be recovered and reused to a much larger extent.

Material waste – a multi-faceted sustainability issue

Today's unsustainable handling of e-waste leads to pollution, health hazards and the loss of valuable natural resources, such as copper, gold and rare earth metals. According to the United Nations University, electronic waste is the fastest growing waste stream in the world, with more than 50 million metric tons generated every year. It is estimated that only 20 percent of the waste is handled in a proper way. The rest is unaccounted for and risk being incinerated, placed on scrap heaps, or illegally exported to developing countries, often to destinations lacking effective legislation that regulates how e-waste should be managed. In these countries, products are manually disassembled, burned in the open air or dissolved in acid by local laborers including children, without adequate protective equipment – leading to severe health problems.

The packaging is also a sustainability issue. Packaging material has a short lifetime and generates large volumes of waste. Using several types of materials that are difficult to separate makes recycling a challenge.

Our approach: prevent e-waste and recover materials safely

The most important way of reducing e-waste is to use products longer. Read more about this in chapter 6. Once products have reached the end of their usable life, they must be collected for remanufacturing, refurbishing or recycling. Product packaging must be designed in a way that enables reuse and recycling.

Criteria in chapter 8 focus on:

- Saving natural resources and limiting hazardous waste by requiring that all packaging materials must be easily separable if not reusable.
- Increase the use of post-consumer recycled plastics in product packaging when it is not possible to substitute them with other non-plastic materials.
- Ensuring that brand owners actively participate in e-waste reduction through offering product take-back in all sales countries and utilizing a significant portion of certified reuse and recycling facilities.

8.1 Product packaging

Background

Packaging is a well-known environmental problem that is regulated in many countries worldwide. Packaging material has a short lifetime and generates large volumes of waste. More than 50% of global waste ends up in landfills or open dumps.

- To reduce the waste generated by packaging materials, it shall be possible to separate them into single material types without the use of tools so that material can be recycled instead of becoming waste.
- Even for packaging materials that may be separated into single materials, little of the plastic is properly recycled. Plastics that degrade into microplastics should be prevented from entering landfills or waterways, as the incomplete degradation process leads to the accumulation of highly mobile microplastics in the environment.

Definitions

Applicability

All product categories.

8.1.1 Mandate

- All parts of the packaging of the certified product weighing more than 25 grams must be possible to separate into single material types without the use of tools.
- For product packaging solutions that are comprised of $\geq 20\%$ plastic, by weight of all packaging materials, the following must be fulfilled:
 - $\geq 50\%$ of the total plastic packaging must be composed of post-consumer recycled plastics, by weight.

Submit the following to an approved verifier:

- A completed and signed product form (chapter 11.3)
- Completed post-consumer recycled content template - packaging section.

The following is submitted to TCO Development:

- A copy of the verification report(s) from a verifier approved by TCO Development.

The following is submitted to TCO Development and may be published:

- Total weight of all packaging materials
- Total weight of all plastic content in the packaging solution
- Total weight of post-consumer recycled plastic materials
- Percentage of post-consumer recycled plastics

8.1.2 Clarification

Packaging solutions that contain more than one individual product are not covered by the mandate, such as bulk packaging solutions.

Document proof from the material vendor must be provided for each part containing post-consumer recycled plastics if it is to be included in the PCR percentage. If no proof exists, then 0% must be reported.

The following information must be submitted to an approved verifier

For each packaging part weighing more than 0,5g, the following must be reported in the “postconsumer recycled content & packaging template”, packaging tab:

- Material Type
- Weight of part
- Weight of plastics in part
- Weight of PCR plastic content
- PCR material manufacturer name
- PCR material identifier

The post-consumer recycled content & packaging template is available at tcocertified.com/certification-documents

8.2 E-waste management

Background

Enormous amounts of e-waste is generated every year. It is one of the world's fastest growing waste streams, and much of it is exported to developing countries, burdening local communities with this global problem. Unsafe handling of e-waste causes pollution, human health hazards and the loss of valuable, finite resources. The Basel Convention governs the export of many types of electronic waste, however, it is not properly implemented in all countries. To help reduce the e-waste problem, manufacturers need to provide mechanisms to take back their products. This is consistent with the principle of individual producer responsibility, where each manufacturer is financially responsible for managing its own branded products at end-of-use. The purpose of this criterion is to influence the expansion of better electronic waste management practices to more countries.

Applicability

All product categories.

8.2.1 Mandate

The brand owner must annually complete the e-waste management template and prove that:

- In all countries where the certified product is sold, the brand owner offers product take-back.
- At least 40% of all first-tier reuse- and recycling facilities used by non-EPR take-back systems are certified according to R2, e-Stewards, WEEELABEX, EN50625, or equivalent.

Submit the following to an approved verifier:

- A completed and signed brand owner product form (chapter 11.4).
- A filled-out TCO Certified E-waste management template covering the previous calendar year.

The following is submitted to TCO Development:

- A copy of the verification report(s) from a verifier approved by TCO Development.
 - The e-waste management template must be uploaded annually in TCO Certified Portal
-

8.2.2 Clarification

Reporting period

The reporting must be submitted by 31 August each year. Each reporting period is the previous calendar year. The reporting applies until one year after the certificate has expired.

Reporting and verification guideline

The brand owner must complete the E-waste template. In this template the brand owner will provide the following information:

1. The number of certified products that were manufactured.

2. The take-back volume of products (in numbers) by the brand owner for each product category. (take-back carried out by EPRs systems, which is mandatory/approved by local law/government are excluded)
 - a. The number of products processed for Reuse
 - b. The number of products processed for Recycling
3. The name and weblink to all used take-back systems (EPR and non-EPR).
4. All countries in which the certified products were sold together with one take-back system covering the country.
5. The name and address of all first-tier reuse- and recycling facilities used by the non-EPR take-back systems to process the products.
 - a. The certificates held by the first-tier reuse- and recycling facilities used to process the products. (i.e. R2, e-Stewards, WEEELABEX, EN50625, or equivalent.)

The e-waste management template can be found at <https://tcocertified.com/certification-documents/>

The number of certified products that were manufactured can be reported per product category.

For Part 2 - Point 1 - The take-back can be handled by an EPR or by the Brand owner.



draft 2

